

DURABILITY

A Guide for Residential Builders and Designers

BY DESIGN

PATH
PARTNERSHIP FOR ADVANCED TECHNOLOGIES IN HOUSING

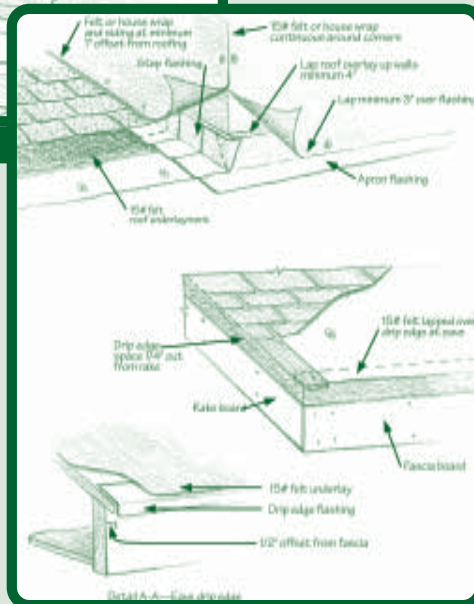
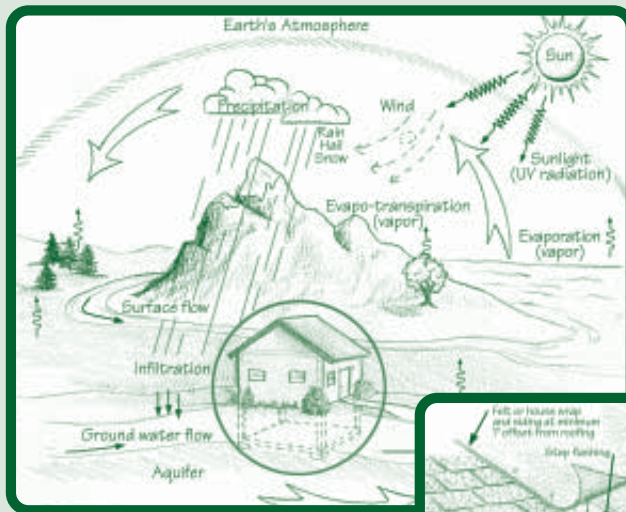

U.S. Department of Housing and Urban Development
Office of Policy Development and Research

PATH (Partnership for Advancing Technology in Housing) is a new private/public effort to develop, demonstrate, and gain widespread market acceptance for the "Next Generation" of American housing. Through the use of new or innovative technologies, the goal of PATH is to improve the quality, durability, environmental efficiency, and affordability of tomorrow's homes.

PATH is managed and supported by the U.S. Department of Housing and Urban Development (HUD). In addition, all federal agencies that engage in housing research and technology development are PATH Partners, including the Departments of Energy, Commerce, and Agriculture, as well as the Environmental Protection Agency (EPA) and the Federal Emergency Management Agency (FEMA). State and local governments and other participants from the public sector are also partners in PATH. Product manufacturers, home builders, insurance companies, and lenders represent private industry in the PATH Partnership.

To learn more about PATH, please contact



451 7th Street, SW
Washington, DC 20410
202-708-4277 (phone)
202-708-5873 (fax)
e-mail: pathnet@pathnet.org
website: www.pathnet.org

Visit PD&R's website
www.huduser.org
to find this report and others sponsored by
HUD's Office of Policy Development and Research (PD&R).

Other services of HUD USER, PD&R's Research Information Service, include listservs; special interest, bimonthly publications (best practices, significant studies from other sources); access to public use databases, and a hotline 1-800-245-2691 for help accessing the information you need.

Durability by Design

A Guide for Residential Builders and Designers

Prepared for

U.S. Department of Housing and Urban Development
Washington, DC

Contract No. C-OPC-21289 (T-002)

by

NAHB Research Center, Inc.
Upper Marlboro, MD

May 2002

ACKNOWLEDGMENTS

This guide was written by the NAHB Research Center, Inc. with support from the U.S. Department of Housing and Urban Development. The NAHB Research Center had generous contributions from many groups and individuals who have helped to develop the practices and methods that make houses stand the test of time. The primary author of this guide at the NAHB Research Center was Jay Crandell, P.E.. Contributing authors and reviewers include Michael Grothe, James Lyons, and Jeanne Leggett Sikora. Illustrations and figures were drawn by Elliott Azzam.

NOTICE

The work that provided the basis for this publication was supported by funding under a grant with the U.S. Department of Housing and Urban Development. The substance and findings of the work are dedicated to the public. The authors are solely responsible for the accuracy of the statements and interpretations contained in this publication. Such interpretations do not necessarily reflect the views of the Government.

While the information in this document is believed to be accurate, neither the authors, nor reviewers, nor the U.S. Department of Housing and Urban Development, nor the NAHB Research Center, Inc., nor any of their employees or representatives makes any warranty, guarantee, or representation, expressed or implied, with respect to the accuracy, effectiveness, or usefulness of any information, method, or material in this document, nor assumes any liability for the use of any information, methods, or materials disclosed herein, or for damages arising from such use.

ABOUT THE NAHB RESEARCH CENTER

The NAHB Research Center, Inc. is a not-for-profit subsidiary of the National Association of Home Builders (NAHB). NAHB has over 203,000 members, including 60,000 builders who build more than 80 percent of new American homes. The Research Center conducts research, analysis, and demonstration programs in all areas relating to home building and carries out extensive programs of information dissemination and interchange among members of the industry and between the industry and the public.

FOREWORD

Few people intentionally consider durability when designing a home, but rather rely on experience and market acceptance to make design decisions. This approach to design works best in a stable housing market where architectural preferences and material choices do not change or change very slowly. The housing market, however, tends to be dynamic rather than stable and new materials and preferences influence the market continuously, sometimes in dramatic ways. This dynamic condition also places a responsibility on designers and builders to properly apply their experiences, which are often based on older construction methods and materials, to new materials and design conditions. As a result, it is important to understand why certain practices have been effective (or ineffective) in the past so that they can be properly interpreted and considered in the design and construction of modern homes.

This manual titled *Durability by Design: A Guide for Residential Builders and Designers* is intended to raise the awareness and understanding of building durability as a design consideration in housing. The Guide covers basic concepts of durability and presents recommended practices — including numerous construction details and design data — for matters such as moisture management, ultraviolet (UV) protection, insects, decay, corrosion, and natural hazards. Some attention is also given to matters that may be considered serviceability issues related to normal wear-and-tear, aesthetics, or functions not immediately associated with durability.

The contents of this Guide will help to preserve and promote “tried-and-true” practices and concepts related to housing durability, and present them in a manner that can be used to cost-effectively design the durable homes of the future.

Lawrence L. Thompson
General Deputy Assistant Secretary for
Policy Development and Research



Table of Contents

ACKNOWLEDGMENTS	I
FOREWORD	II
CHAPTER 1 - INTRODUCTION	1
1.1 General	1
1.2 Durability Requires Commitment	2
1.3 Overview	2
CHAPTER 2 - CONCEPTS OF DURABILITY	3
2.1 General	3
2.2 What is Durability?	3
2.3 Building Codes and Durability	5
2.4 Factors Influencing Durability	5
2.5 Common Durability Issues	8
CHAPTER 3 - GROUND AND SURFACE WATER	11
3.1 General	11
3.2 Recommended Practices	11
CHAPTER 4 - RAIN AND WATER VAPOR	15
4.1 General	15
4.2 Recommended Practices	15
CHAPTER 5 - SUNLIGHT	39
5.1 General	39
5.2 Recommended Practices	40
CHAPTER 6 - INSECTS	45
6.1 General	45
6.2 Recommended Practices	45
CHAPTER 7 - PROTECTION AGAINST DECAY AND CORROSION	51
7.1 General	51
7.2 Recommended Practices	51
CHAPTER 8 - NATURAL HAZARDS	59
8.1 General	59
8.2 Recommended Practices	60
CHAPTER 9 - MISCELLANEOUS	63
9.1 General	63
9.2 Plumbing	65
9.3 HVAC	65
9.4 Exterior Finishes	66
BIBLIOGRAPHY	69
GLOSSARY	72
APPENDIX A - DURABILITY CHECKLISTS	73
APPENDIX B - ESTIMATED LIFE-EXPECTANCY OF BUILDING MATERIALS AND PRODUCTS	74

List of Tables

2.1 – Top Five Homeowner Warranty Claims -----	9
2.2 – Major Expenditures for Repairs, Maintenance, and Replacements to Owner Occupied Homes (1998) -----	9
4.1 – Recommended Minimum Roof Overhang Widths for One- and Two-Story Wood Frame Buildings -----	17
4.2 – Roof Pitch Factors -----	19
4.3 – Gutter Capacity (roof area served in square feet) Based on 1 in/hr Rainfall Intensity -----	19
4.4 – Recommended Drainage Plane Characteristics for Exterior Walls in Various Climate Conditions -----	22
4.5 – Drainage Plane and Vapor Retarder Material Properties -----	23
4.6 – Recommended Vapor Retarder Characteristics for Building Exteriors or Interiors in Various Climate Conditions -----	24
4.7 – Roof and Crawl Space Ventilation Recommendations -----	36
4.8 – Caulk Characteristics and Application Recommendations -----	37
5.1 – Solar Angle Factors -----	40
7.1 – Recommended Finishes for Exterior Wood -----	54
7.2 – Recommended Preservative Retention Levels for CCA-Treated Lumber -----	55
7.3 – No-Rust Service Life of Nails Exposed to Normal Outdoor Environment -----	56
8.1 – Hurricane Damage Statistics (single-family homes) -----	59
8.2 – Northridge Earthquake Damage Statistics (percent of single-family homes) -----	60

List of Figures

- 2.1 – The House and the “Duralogic Cycle” ----- 7
- 2.2 – Loss of Function vs. Time for Three Hypothetical Materials
or Products of Different Quality Levels (poor, acceptable, and best) ----- 8
- 3.1 – Bore Hole Used for Preliminary Site Investigation ----- 12
- 3.2 – Site Grading and Surface Drainage ----- 13
- 3.3 – Basement Construction and Optional Enhancements for Wet Site Conditions ----- 13
- 3.4 – Typical Frost-Protected Shallow Foundation with Perimeter Drain ----- 14
- 4.1 – Frequency of Moisture Problems in Walls of Selected Buildings in a Moist, Cool Climate 16
- 4.2 – Roof Overhangs ----- 17
- 4.3 – Climate Index Map Based on Wood Decay Potential ----- 17
- 4.4 – Roof Gutters and Discharge Methods ----- 18
- 4.5 – Rainfall Intensity Map of the United States ----- 19
- 4.6 – Weather Barrier Construction ----- 21
- 4.7 – Heating Degree Day (HDD) Map of the United States (65°F basis) ----- 25
- 4.8a,b – Basic Roof Flashing Illustrations ----- 27, 28
- 4.9 – Eave Flashing for Preventing Ice Dams ----- 28
- 4.10 – Window Flashing Illustration ----- 29
- 4.11 – Window Sill and Jamb Flashing Detail ----- 30
- 4.12 – Window Flashing for Severe Weather ----- 31
- 4.13 – Door and Head Trim Flashing Detail ----- 31
- 4.14 – Deck Ledger Flashing Detail ----- 32
- 4.15 – Typical Brick Veneer Flashing Details ----- 33
- 4.16 – Brick Veneer Flashing at Roof Intersections ----- 34
- 5.1 – Solar Radiation Map of the United States ----- 39
- 5.2 – Effect of Building Latitude on Effectiveness of Overhangs ----- 40
- 5.3 – Effect of Surface Coloration on Solar Heat Gain ----- 41

5.4 – Illustration of Solarscaping	42
6.1 – Termite Probability (Hazard) Map	46
6.2 – Extent of Recorded Termite Damage	46
6.3 – Use of Termite Shields	49
6.4 – Use of Concrete as a Termite Barrier	50
7.1 – Details to Separate Wood from Ground Moisture	52

CHAPTER 1 - Introduction

1.1 General

Of all the issues that must be considered when building a home, durability has perhaps the broadest impact on long-term performance, the most complex set of physical interactions, and the largest potential economic consequence. Fortunately, many of the best practices intended to improve durability require little more than good judgment and a basic knowledge of the factors that affect building durability.

A fundamental element of this discussion is the very meaning of durability. For this guide, durability may be defined as the ability of a material, product, or building to maintain its *intended function* for its *intended life-expectancy* with *intended levels of maintenance* in *intended conditions of use*.¹ Obviously this definition may take on different meanings for different groups (e.g., builders, homeowners, manufacturers), implying that communication and education are key aspects that affect durability.

Addressing durability is not a pursuit of extremes, but rather a pursuit of cost-effectiveness in terms of initial and long-term (i.e., maintenance, replacement) costs. Trying to make a home too durable can add so much to the cost of a new home that it may deny access to the basic need of decent shelter in the present time. Erring in the other direction can result in an equally disastrous future in terms of homeowner complaints, unsafe or unhealthy living conditions, and excessive maintenance and repair costs.

The above comparison assumes that there is a direct trade-off between durability and affordability of homes. While the saying, “you get what you pay for”, is generally true, there are many design and construction practices that have minimal construction cost impacts, and significant durability benefits. The benefits may be measured in terms of maintenance, repair, general function of the home and its component parts over time, enhanced business reputation, and customer satisfaction. Moreover, many such practices are well-known and need not be re-invented, but only communicated to the builder, designer, and consumer.

This guide strives to reinforce “tried and true” practices that add to the durability of homes, shed some light on areas of confusion, and identify important trade-offs between cost and durability that should be carefully considered by the designer, builder, and homeowner. The guide focuses on practical solutions in key areas that are known to create significant and reoccurring durability problems. The guide also identifies timeless design concepts and principles that, once understood, can be applied to a variety of conditions and applications in modern housing design, construction, and maintenance. Finally, an attempt is made to draw attention to innovative materials and techniques that hold promise for improved durability in houses of the future.

WHY IS DURABILITY IMPORTANT?

- *Avoidance of short-term durability or performance problems (i.e., callbacks) is important to the builder's and designer's reputation and business profitability.*
- *The long-term condition of a home is important to retaining its investment value as well as its continued function as a safe, healthy, and aesthetic living environment.*
- *Poor durability adds to the operating and maintenance cost of home ownership.*
- *Failure to meet reasonable expectations for durability increases liability exposure.*
- *People don't like maintenance (i.e., high durability and low maintenance are important sales and purchasing factors).*
- *New products designed without adequately considering durability can prematurely fail, leading to both customer dissatisfaction and manufacturer losses.*

¹ For a standardized definition of durability, refer to ASTM E632-82 (1996) *Standard Practice for Developing Accelerated Tests to Aid Prediction of the Service Life of Building Components and Materials*, American Society of Testing and Materials, West Conshohocken, PA (www.astm.org)

DURABILITY CHECKLISTS

To assist in using this guide and in applying selected recommended practices, a durability checklist is provided in Appendix A. It lists various actions or considerations that should occur during the course of designing and constructing a house. Also included are action items appropriate for homeowners. Feel free to use and modify the checklist to suit your needs and level of interest.

1.2 Durability Requires Commitment

Building and designing a durable home does not require a building scientist or durability specialist, but it does require commitment. Achieving durable construction not only includes the basics—material selection, verification of manufacturer warranties, and passing minimum code-required inspections—but it also involves a reasonable consideration of key details in the production of a home and understanding of the interactions between different materials and trades. Furthermore, durability also requires the appropriate *use and installation* of specified materials and, equally important, the functional integration of various materials and products such that the house performs as intended. In tandem, durability design criteria should incorporate concepts such as ease-of-repair or replacement where appropriate.

Building a durable home is relatively simple if the right information and guidance is available. In fact, including durability as a design criterion (though often subjective in nature) can add marketable features to homes at very little additional cost or design effort. Some features may already be incorporated into existing designs while others can be added through a simple modification of plans and specifications.

Admittedly, although some aspects of designing for durability are rather straight forward—such as the building code requirement of keeping untreated wood from contacting the ground—other tasks may involve somewhat greater effort. Achieving cost-effective and durable construction requires a reasonable commitment in the planning, design, and construction of houses.

1.3 Overview

This guide is arranged in the most practical and user-friendly way possible. However, there are many interrelated topics, which make any arrangement of information on durability somewhat challenging. To the degree possible, redundancy in content is minimized and interrelated topics or discussions are appropriately cross-referenced so that the reader can seek the depth of information needed with relative ease. A glossary is provided at the end of this guide to aid in the proper understanding of this writing.

The chapters of this guide are organized mainly by the factors that affect durability, i.e., ground and surface water, rain and water vapor, sunlight, etc. Within each chapter, the first section is always directed toward a general understanding of the concepts and issues related to the specific topic(s) of the section. An effort has been made to include geographically-based data and other technical information that allows the reader to quickly determine the relevance of a particular durability issue to local conditions or requirements.

Chapter 2 introduces the topic of durability and presents some important over-arching concepts and issues that create a foundation of understanding upon which the remainder of the guide builds. Chapter 3 addresses concerns related to ground and surface water, primarily affecting site and foundation design. Chapter 4 addresses rain and water vapor and their effect on the above-ground structure. Combined, Chapters 3 and 4 cover some of the most prevalent housing durability issues related to water—the most formidable durability factor known to man. Chapter 5 deals with sunlight and methods to mitigate the effects of ultraviolet (UV) radiation on building materials. In Chapter 6, methods to prevent insect infestation and damage are presented. Chapter 7 addresses the issue of wood decay and corrosion of metal fasteners, both associated with the effects of moisture. Practices to improve the durability of homes that are subject to natural hazards, such as hurricanes and earthquakes, are presented in Chapter 8. Finally, Chapter 9 covers several miscellaneous and “serviceability” issues related to durability, including items such as wear-and-tear, nuisances, plumbing/mechanical/electrical systems, and exterior appurtenances.

CHAPTER 2 - Concepts of Durability

2.1 General

In this chapter, some fundamental concepts of durability related to the design of residential buildings are addressed. This background information is intended to establish a baseline of understanding and to introduce concepts and information important to developing a balanced perspective regarding durability.

Before discussing the concept of durability, some discussion on unrealistic notions surrounding the topic of durability is in order. Despite the best efforts of the most knowledgeable and capable people, unforeseen problems will continue to occur in homes (e.g., premature failures of building products, components, and systems). This undesirable outcome is often a consequence of taking calculated risks in moving toward more resource efficient, affordable, functional, and appealing homes. Further, it is impractical to think that the durability of all building components and systems can be exactly designed and crafted such that they all last just as long as intended. (This point is a matter of poetic parody, see inset of “The Wonderful One-Hoss Shay” by Oliver Wendell Holmes on the following page). In fact, the service life of building materials and products varies substantially (see Appendix B – Estimated Life-Expectancy of Building Materials and Products). Thus, it can be expected that some components of a home will require some vigilant attention along the way (i.e., maintenance, repair, and eventual replacement of “worn-out” components).

Note that many changes have occurred in home building over the past several decades that will likely affect the durability of houses in the short and long term—some good and some bad. Examples of material changes include the increased use of engineered wood products, adhesives, and plastics, among many others. At the same time, housing designs have tended to grow in complexity and size, thereby increasing exposure to the elements and vulnerability. Also, newer materials and technologies have changed both the susceptibility and exposures of building materials in modern homes. New homes are also increasingly complex to operate and

maintain. In short, there are more durability issues to deal with and more material choices than ever before.

2.2 What is Durability?

Durability is the ability of a material, product, or building to maintain its *intended function* for its *intended life-expectancy* with *intended levels of maintenance* in *intended conditions of use*. However, we all know that the road to success is not just paved with good intentions. Ultimately, what is built must work as expected, or as nearly so as practicable.

What is a reasonable expectation or goal for durability? It depends.

It depends on how much it costs. It depends on the expectations of the end user and the long term investment value of the product. It depends on the local climate. It also depends on expected norms when the end user is not intimately involved with or knowledgeable of various design decisions and their implications. It also depends, of course, on the material itself.

For example, a house is expected (at least in theory) to last for 75 years or more with normal maintenance and replacement of various components (see Appendix B – Estimated Life-Expectancy of Building Materials and Products). But then again, what one person considers normal maintenance may be perceived differently by another. Durability is, therefore, an exercise in the management of expectations as well as an application of technology. For this reason, some builders and designers make significant efforts to inform their clients and trade contractors about reasonable expectations for the durability, performance, maintenance, and operation of a home. Some references to help in this matter include:

- *Caring For Your Home: A Guide to Maintaining Your Investment* (NAHB/Home Builder Press, 1998);

THE DEACON'S MASTERPIECE: OR THE WONDERFUL "ONE-HOSS SHAY"

Oliver Wendell Holmes

Have you heard of the wonderful one-hoss shay,
That was built in such a logical way
It ran a hundred years to a day,
And then, of a sudden, it—ah, but stay,
I'll tell you what happened without delay,
Scaring the parson into fits,
Frightening people out of their wits,—
Have you ever heard of that, I say?

Seventeen hundred and fifty-five.
Georgius Secundus was then alive,—
Snuffy old drone from the German hive.
That was the year when Lisbon-town
Saw the earth open and gulp her down,
And Bradock's army was done so brown,
Left without a scalp to its crown.
It was on the terrible Earthquake-day
That the Deacon finished the one-hoss shay.

Now in building of chaises, I tell you what,
There is always *somewhere* a weakest spot, —
In hub, tire, fellow, in spring or thill.
In panel, or crossbar, or floor, or sill,
In screw, bolt, thoroughbrace, —lurking, still,
Find it somewhere you must and will, —
Above or below, or within or without, —
And that's the reason, beyond a doubt,
A chaise *breaks down*, but doesn't *wear out*.

But the Deacon swore (as Deacons do,
With an "I dew vum," or an "I tell yeou")
He would build one shay to beat the taown
'N' the keounty 'n' all the kentry raoun';
It should be so built that it *couldn't* break daown.
—"fur," said the Deacon, "'t's mighty plain
Thut the weakes' place mus' stan' the strain;
'n' the way t' fix it, uz I maintain, is only jest
T' make that place uz strong uz the rest."

So the Deacon inquired of the village folk
Where he could find the strongest oak,
That couldn't be split nor bent nor broke, —
That was for spokes and floor and sills;
He sent for lancewood to make the thills;
The crossbars were ash, from the straightest trees,
The panels of white-wood, that cuts like cheese,
But lasts like iron for things like these;
The hubs of logs from the "Settler's ellum," —
Last of its timber, —they couldn't sell 'em,
Never an axe had seen their chips,
And the wedges flew from between their lips,
Their blunt ends frizzled like celery-tips;
Step and prop-iron, bolt and screw,
Spring, tire, axle, and linchpin too,
Steel of the finest, bright and blue;
Thoroughbrace, bison-skin, thick and wide;
Boot, top, dasher, from tough old hide
Found in the pit when the tanner died.
That was the way he "put her through." —
"There!" said the Deacon, "naow she'll dew."
Do! I tell you, I rather guess
She was a wonder, and nothing less!
Colts grew horses, beards turned gray,
Deacon and deaconess dropped away,
Children and grandchildren—where were they?

But there stood the stout old one-hoss shay
As fresh as on Lisbon-earthquake-day!

EIGHTEEN HUNDRED; —it came and found
The Deacon's masterpiece strong and sound.
Eighteen hundred increased by ten; —
"Hahnsum kerridge" they called it then.
Eighteen hundred and twenty came; —
running as usual; much the same.
Thirty and forty at last arrive,
And then came fifty, and FIFTY-FIVE.

Little of all we value here
Wakes on the morn of its hundredth year
Without both feeling and looking queer.
In fact, there's nothing that keeps its youth,
So far as I know, but a tree and truth.
(This is a moral that runs at large;
Take it. —You're welcome. —No extra charge.)

FIRST OF NOVEMBER, —the Earthquake-day. —
There are traces of age in the one-hoss shay,
A general flavor of mild decay,
But nothing local, as one may say.
There couldn't be—for the Deacon's art
Had made it so like in ever part
That there wasn't a chance for one to start.
For the wheels were just as strong as the thills,
And the floor was just as strong as the sills,
And the panels just as strong as the floor,
And the whippletree neither less nor more,
And the back-crossbar as strong as the fore,
And spring and axle and hub encore.
And yet, *as a whole*, it is past a doubt
In another hour it will be *worn out!*

First of November, fifty-five!
This morning the parson takes a drive.
Now, small boys, get out of the way!
Here come the wonderful one-hoss shay,
Drawn by a rat-tailed, ewe-necked bay.
"Huddup!" said the parson.—Off went they.
The parson was working his Sunday's text, —
Had got to *fifthly*, and stopped perplexed
At what the—Moses—was coming next.
All at once the horse stood still,
Close by the meet'n'-house on the hill.

First a shiver, and then a thrill,
Then something decidedly like a spill, —
And the parson was sitting upon a rock,
At half-past nine by the meet'n'-house clock—
Just the hour of the Earthquake shock!
What do you think the parson found,
When he got up and stared around?
The poor old chaise in a heap or mound,
As if it had been to the mill and ground.
You see, of course, if you're not a dunce,
How it went to pieces all at once, —
All at once, and nothing first, —
Just as bubbles do when they burst.

End of the wonderful one-hoss shay,
Logic is logic. That's all I say.

- *Your New Home and How to Take Care of It* (NAHB/Home Builder Press, 2001); and
- *A Builder's Guide to Marketable, Affordable, Durable, Entry-Level Homes to Last* (HUD, 1999).

2.3 Building Codes and Durability

Numerous requirements found in building codes imply a minimum level of durability performance or expectation. Building codes specify the minimum type and nature of various materials, including certain installation requirements that may vary according to local or regional climatic, geologic, or biologic conditions.

Despite the extensive framework of requirements found in building codes, there are still gaps in the details or in the reliability of the information for any specific application or local condition. In some instances, the requirements are clear, e.g., “a metal connector with minimum G60 galvanic coating shall be used” and in other cases the guidance is quite vague, e.g., “use corrosion resistant fasteners.” Likewise, standardized durability tests for materials are rarely calibrated to performance in actual conditions of use.

Further, building codes and standards are often driven by various opinions and data or experiences expressed in the code development process. Sometimes the evidence is contradictory or incomplete. Nonetheless, it is legally required that a builder and designer adhere to code prescribed requirements related to durability and, when deemed appropriate, seek approval of alternate means and methods of design or construction that are at least equivalent to that required or implied by the locally approved building code.

The major U.S. model building codes currently available are listed in the sidebar to the right. However, the reader should be informed that earlier versions may be in use locally since these codes do not become law until they are legislatively adopted at the local level. In addition, these national model codes are often amended to address local issues and concerns.

2.4 Factors Influencing Durability

The manner in which materials and buildings degrade over time depends on their physical make-up, how they were installed, and the environmental conditions to which they are subjected. It is for this reason that environmental conditions, such as humidity and temperature, are carefully controlled in museums to mitigate the process of degradation. Even then, artifacts still require periodic care and maintenance.

Houses, depending on where they are located with respect to geology and climate, are more or less subjected to various types of durability “factors.” Each of the “factors” listed below, which can be managed but not externally controlled, is addressed in this guide:

- Moisture
- Sunlight (UV radiation)
- Temperature
- Chemicals
- Insects
- Fungi
- Natural Hazards
- Wear and Tear

In essence, a house is part of an environmental cycle as depicted in Figure 2.1 and is subject to the same powerful forces of nature that create and then erode mountains, cause organic matter to decompose, and change the face of the earth.

MODEL U.S. BUILDING CODES

- *One- and Two-Family Dwelling Code (OTFDC)*, Council of American Building Officials (CABO), Falls Church, VA, 1995.
- *International Residential Code (IRC)*, International Code Council, Inc., Falls Church, VA, 2000.
- *International Building Code (IBC)*, International Code Council, Inc., Falls Church, VA, 2000.
- *Uniform Building Code (UBC)*, International Conference of Building Officials (ICBO), Whittier, CA, 1997.
- *Standard Building Code (SBC)*, Southern Building Code Conference International (SBCCI), Birmingham, AL, 1999.
- *National Building Code (NBC)*, Building Officials and Code Administrators International, Inc., Country Club Hills, IL, 1999.

Over the course of time, the greatest concerns (and impacts) regarding durability are those processes that occur constantly over the life of a home. Most notable of these factors is moisture. Moisture comes in many forms (i.e., rain, snow, ice, vapor) and is linked to other durability factors. For instance, moisture must be present in sufficient quantity to promote corrosion (e.g., chemical degradation), insect habitation (e.g., subterranean termites), and rot (e.g., wood decomposition). By controlling exposure to moisture, many other durability problems are also solved. Other problems, such as mold and indoor air quality, are also related to moisture. It is for this reason that there is a major emphasis on moisture in this guide. In fact, the effects of moisture on building durability have been associated with enormous economic impact in the United States for wood construction alone.

The UV radiation from sunlight also has a tremendous impact on the exterior finishes of homes. For example, sunlight causes coatings to chalk-up or fade in color, plastics to degrade, wood to weather, and asphalt roof shingles to become brittle. Sunlight can also fade carpets, drapes, and furnishings inside homes. In relation to moisture, sunlight can heat surfaces and drive moisture into or out of materials and buildings; intermittent sunlight can also cause temperature cycling.

Temperature causes materials to expand and contract. Temperature cycling, particularly in the presence of water, can cause some materials to weaken or fatigue. Thermal expansion and contraction can also cause materials to buckle and warp and, therefore, become less effective in their intended function (e.g., buckling of improperly installed siding which may allow increased rain water penetration). When temperature cycles above and below the freezing temperature of water, even more damaging effects can occur to materials with high moisture content.

Chemical reactions, most often occurring in the presence of water, are responsible for a variety of durability problems and can dramatically accelerate otherwise normal rates of degradation. For example, a galvanic reaction between dissimilar metals can cause one metal to degrade relatively rapidly. This effect is evidenced by more rapid corrosion of galvanized fasteners in preservative-treated wood (i.e., chromated copper arsenate or CCA) relative to untreated wood. Another example is the pitting of copper piping due to the presence of certain salts and minerals in water or soil.

Certain *insects* are particularly fond of wood and, in fact, depend on wood for food. In the presence of wood-consuming insects such as termites and carpenter ants, an unprotected wood-frame home is nothing more than a free food source.

Natural hazards form a special class of durability concerns that are generally associated with localized climatic or geologic conditions. These conditions are generally considered from a life-safety perspective, but they are considered here in the broader sense of durability. For example, a life-safety provision in a building code may require that an extreme wind or earthquake event be considered in the structural design of a home. However, durability impacts may be realized in even moderate or mild natural events. Even a mild hurricane can cause significant water penetration and salt deposition resulting in immediate (e.g., flooding) and long-term (corrosion, mold growth) damage. Natural hazards that affect durability include hurricanes, earthquakes, floods, wildfires, hail, snow, thunderstorms, and tornadoes.

Wear and tear is simply the result of abrasion, physical damage, staining and other symptoms of continued use. Homeowner habits and lifestyles are particularly important for this durability factor.

In summary, all houses are under attack by a mighty and unstoppable foe, namely the forces of nature, along with kids, pets, and other “use conditions.” Recognizing this issue is not intended to signal retreat or resignation, but rather to draw attention to the need for action.

Of course, actions must be practical in that the benefits of improved durability should be reasonably balanced with the costs and efforts of doing so. Appropriate actions to consider include selecting high quality material, using appropriate design detailing, following proper installation procedures, and performing judicious maintenance.

The concept of durability as a function of material quality is illustrated in Figure 2.2. Note the different levels of maintenance required to retain acceptable function of the three hypothetical materials in Figure 2.2. In many cases, however, installation quality may actually be more important than material quality. In other cases design decisions can have a profound effect on making poor quality materials or installations perform satisfactorily. Proper maintenance and repair are critical factors in some instances. Usually, all of these factors are important considerations.

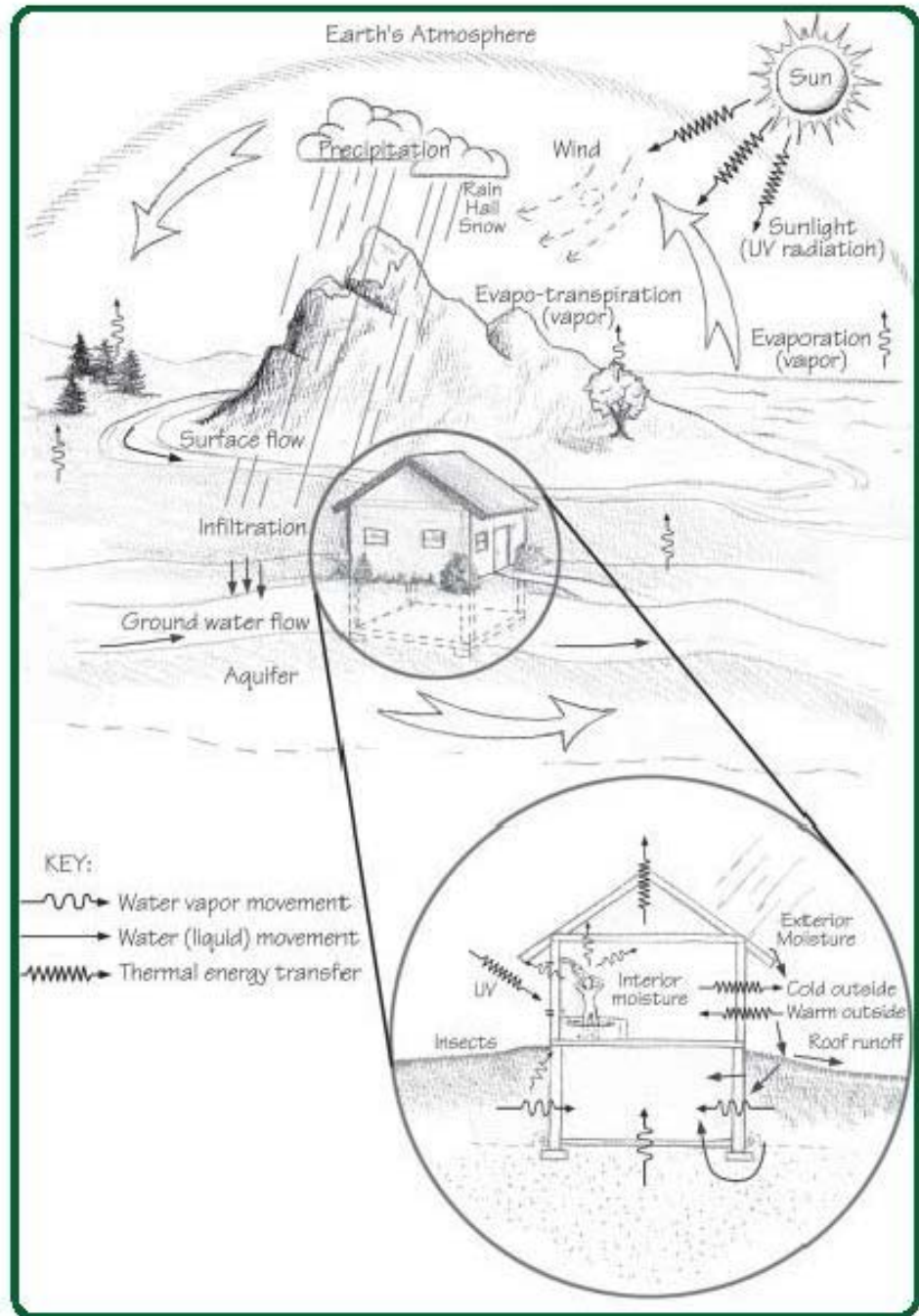

Figure 2.1 - The House and the "Duralogic Cycle"

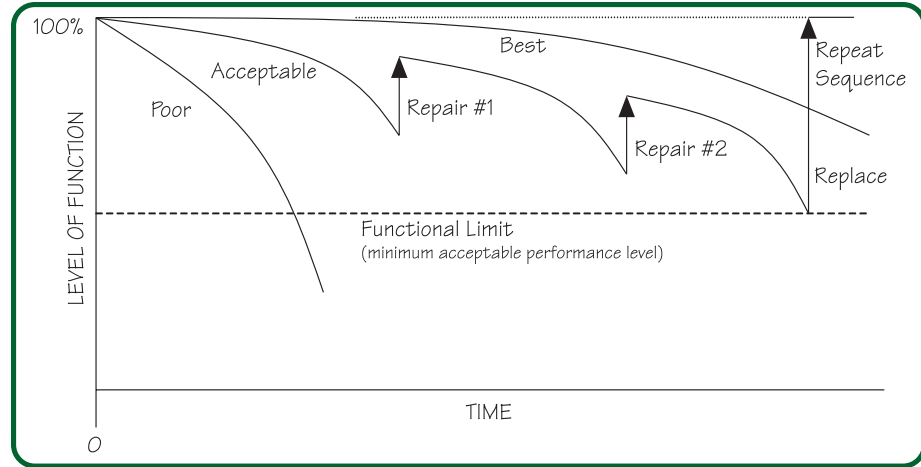

Figure 2.2 - Loss of Function vs. Time for Three Hypothetical Materials or Products of Different Quality Levels (poor, acceptable, and best)

Enough said on the concepts, theory, and philosophy of designing for durability. The next section reviews some of the most common durability or performance issues experienced in modern homes, many of which are addressed in the remaining parts of this guide.

2.5 Common Durability Issues

The type and frequency of durability related problems and general performance problems experienced in modern homes can be gathered from various information sources, such as trade organizations, industry surveys, warranty claims, popular literature, and others. These problems may be related to design, materials, methods, maintenance, or a

combination of these factors. For this reason, this guide focuses primarily on design issues, but also has significant content on installation, materials selection, and maintenance topics as well.

The following summaries, including Tables 2.1 and 2.2, illustrate some commonly reported durability issues:

Problem Areas in New Construction

- Paints/Caulks/Finishes
- Flooring
- Windows and Skylights
- Doors
- Foundations and Basements
- Siding and Trim
- Structural Sheathing
- Wallboard
- Foundation Insulation and Waterproofing
- Framing

Source: Survey of builders conducted by NAHB Research Center, Upper Marlboro, MD, January 1992.

Most Frequent House Problems

- Improper Surface Grading/Drainage
- Improper Electrical Wiring
- Roof Damage
- Heating System
- Poor Overall Maintenance
- Structurally-Related Problems
- Plumbing
- Exteriors
- Poor Ventilation

Source: ASHI NEWS Press Release, American Society of Home Inspectors, Des Plaines, IL, 2000.

WHAT'S THE COST OF MAINTENANCE?

Most people don't consider long-term repair and maintenance costs as an issue in making a home purchase. However, a typical annual, out-of-pocket (i.e., not including do-it-yourself tasks) maintenance and repair expenditure is about \$300 to \$600. (Source: NAHB Housing Economics, Nov 1997. Based on data from 1995 American Housing Survey). This amount may actually reflect a tendency to defer maintenance. Items like replacing appliances or HVAC equipment will create even greater costs as a house becomes older.

TABLE 2.1 - TOP FIVE HOMEOWNER WARRANTY CLAIMS

<u>Based on Frequency of Claim</u>	<u>Based on Cost of Claim</u>
Gypsum wall board finish	Foundation wall
Foundation wall	Garage slab
Window/door/skylight	Ceramic tiles
Trim and moldings	Septic drain field
Window/door/skylight frames	Window/door/skylight & other

Source: *Defect Prevention Research Project for Part 9 Houses*, Ontario Home Warranty Program, Canada Mortgage Housing Corporation, Ottawa, Ontario, Canada, November 1994.

Home Builder and Housing Consumer Product Problems

1. Foundations and basements – Leaks, construction cost is higher than the perceived value, difficult to insulate;
2. Paints, caulks, finishes – Caulk shrinkage, premature discoloration and fading, peeling and blistering, mildew growth, imperfections of surface, poor coverage;
3. Windows and skylights – Air and water leakage, glass fogs and frosts;
4. Doors – Warping, poor weather stripping, checking and splitting of panels, swelling;
5. Finish flooring – Seams visible, damages easily, inconsistent color, coming up at edges, poor adhesion;
6. Structural sheathing – Excessive swelling, delamination of sheets;
7. Roofing – Leaks, does not seal properly, wind damage, inconsistent coloration;
8. Siding and trim – Siding buckles, nails bleed, algae grows on it, paint peels, seams are noticeable, moisture induced swelling;
9. Wallboard, interior coverings – Nail pops, finish shows seams and/or nail heads;
10. Framing – Warped/twisted lumber, checking/splitting, too many large knots;
11. HVAC Equipment – Wrong sizing, insufficient warm air.

Source: *Product Failure Early Warning Program*, prepared for NAHB by the NAHB Research Center, Inc., Upper Marlboro, MD, 1996.

All of these summaries of housing durability issues point to the previously mentioned problem areas of installation and material quality, design, and proper maintenance. And while these performance problems are not necessarily related to any specific building product, it's worth mentioning that builders are generally averse to a certain class of products – those that are “too new.” Major product and installation failures that have resulted in class

action lawsuits in the United States have given builders and designers some reason to think twice about specifying new products. Past examples include:

- Exterior Insulated Finish Systems (EIFS);
- Fire-Retardant Treated (FRT) Plywood Roof Sheathing;
- Certain Composite Siding and Roofing Products; and
- Polybutylene Water Piping.

It should be noted, however, that many of these problems have been resolved by subsequent product improvements. For example, EIFS systems are now almost exclusively used with a “drainage plane” system such that any moisture that enters the wall can escape without harm.

In other cases, products such as polybutylene piping have been entirely removed from the market. Although costly examples, these experiences demonstrate the risk and complexity in the development and application of new materials and methods of home construction.

TABLE 2.2 - MAJOR EXPENDITURES FOR REPAIRS, MAINTENANCE, AND REPLACEMENTS TO OWNER OCCUPIED HOMES (1998)

<u>Category</u>	<u>1998 Value (\$ Millions)</u>
Roofing	8,740
Painting and Papering	8,641
HVAC	5,872
Windows and Doors	5,769
Plumbing	3,368
Siding	1,853
Driveways and walkways	1,138
Flooring	826
Electrical	493
Others (including materials on hand)	10,814
TOTAL	47,514

Source: U.S. Department of Housing and Urban Development.

From a recent pilot study² of homes of two different age groups (1970's and 1990's), some important trends and observations regarding durability of housing in one locality (Anne Arundel County, MD) have been identified:

1. The size of roof overhangs decreased between the 1970s and 1990s.
2. Use of vinyl siding and window frames have increased dramatically.
3. When present, signs of poor site grading (i.e., surface depressions next to house) were associated with an increased tendency for foundation cracks.
4. The occurrence of wood rot (predominantly associated with exterior trim) in newer and older homes was 22 percent and 31 percent, respectively.
5. Masonry foundations tended to evidence cracks more frequently than concrete foundations.

²*Assessing Housing Durability: A Pilot Study*, U.S. Department of Housing and Urban Development, Washington, D.C., November 2001

CHAPTER 3 - Ground and Surface Water

3.1 General

Nearly all building sites have some potential to experience problems with ground moisture, particularly when the water table is high or drainage is poor. Poor site drainage and difficult site conditions, such as “loose” soils or fills, can contribute to eventual building settlement, foundation wall cracking, and aggravated moisture problems. Years ago, it was generally much easier to select a suitable building location on a larger site or to seek alternate sites that provide better drainage and bearing support characteristics. However, such a luxury is not easily afforded in today’s market. Thus, this section gives recommendations that recognize the need to be resourceful with the land that is available.

The objective of a foundation is to separate the building materials and the indoor environment from the earth while also providing adequate structural support. The following rules of thumb and recommended practices of Section 3.2 should serve to minimize the potential for durability and performance problems related to foundations (refer to Section 2.5, Common Durability Issues).

RULES OF THUMB

- *Most damp foundations are caused by improper surface drainage.*
- *Wet site – “waterproof” basement walls per code and use a sump pump; damp/dry site – “moisture-proof” basement walls.*
- *Do not build below-ground space below highest seasonal water table level.*
- *Using only typical construction practices, as many as 1 out of 3 basements experience some form of water problem within the first two years.*
- *When in doubt, seek advice from a qualified geotechnical engineer.*
- *Moisture entering a house through the foundation will contribute to potential moisture problems in the above-ground portions of the building, even the attic through added water vapor loading.*

3.2 Recommended Practices

3.2.1 Recommendation #1: Preliminary Site Investigation

The following actions may help to identify potential site problems that can be accounted for in planning and design. An illustration of a typical borehole used to explore subsurface conditions is shown in Figure 3.1.

- Survey the surface conditions and local plant species for signs of seasonal or constant high ground water levels.
- Consider the lay of the land and surface water flow onto and off of the site to ensure that proper surface water drainage can be achieved around the building site.
- Check soil maps from USDA’s Natural Resources Conservation Service or use a hand auger to bore one or more test holes at the proposed building location; and determine general soil type/characteristics and ascertain the water table level (be sure to factor in any seasonal or recent climate conditions such as the amount of precipitation over the previous month or so) (see Figure 3.1). At least one hole should be at the building location and extend at least a couple of feet below the proposed footing elevation. If deeper subsurface problems are expected (as by local experience), then a geotechnical engineer may need to use special drilling equipment to explore deeper below grade to ensure that adequate support and stability exists.

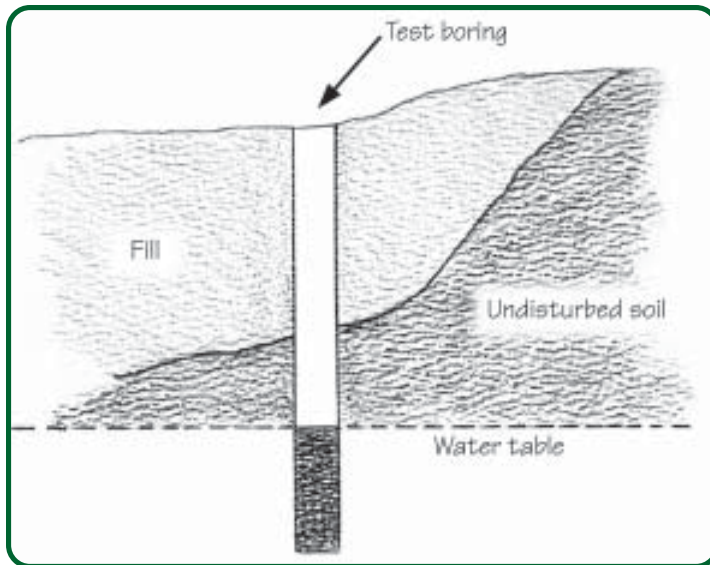

Figure 3.1 - Bore Hole Used for Preliminary Site Investigation

3.2.2 Recommendation #2: Site Grading and Surface Water Drainage

- If possible, test the soil for bearing capacity at the depth and location of proposed footings. A simple hand-held penetrometer (e.g., a standardized metal rod and drop weight) used in accordance with the manufacturer's instructions serves this purpose.
- If fill or questionable soil conditions are suspected (as on a steep slope), the services of a design professional and knowledgeable foundation contractor may be needed to appropriately prepare the site (e.g., compaction) or design a suitable foundation system.
- Do not use basement foundations on sites with high ground water table.
- Avoid silt, heavy clay, or expansive clay backfill, particularly for basement walls. Granular soils are preferable.
- Use minimum 3,000 psi concrete in slabs and foundation walls with welded wire fabric in slabs and light reinforcement (#3 rebar) in foundation walls to control cracking, improve concrete resistance to moisture and weathering, and improve concrete finishing.

Site grading plans should consider the existing natural water flow and change the water flow to direct water away from the building foundation, particularly if the building is located down-slope from a hill or similar land formation that may produce significant rainfall runoff. Use of grassy swales is a common and cost-effective practice when the potential water volume is not large, wetting is not constant, and the swale is not sloped steeply enough to produce high water velocities (see Figure 3.2). The range of acceptable swale slope depends on many factors, but slope should not be less than about 1% to prevent ponding, nor more than about 15% unless rip-rap (4 to 8 inch stone) is used to line the swale with a filter cloth underlay. The grading immediately adjacent to the building should be sloped a minimum of about 4% (or 1/2 inch in 12 inches) for at least 6 feet outward from a building foundation or as far as practical. If concrete flatwork (i.e., patio slabs, driveways, and walks) are adjacent to the building, they should be sloped not less than 2% (about 1/4 inch in 12 inches) away from the building. Backfill should be tamped firmly to prevent excessive settlement or the grade should be adjusted to allow for future backfill settlement. In addition, gutters and gutter drains should be used to further remove roof run-off from the foundation area (See Section 4.2.2).

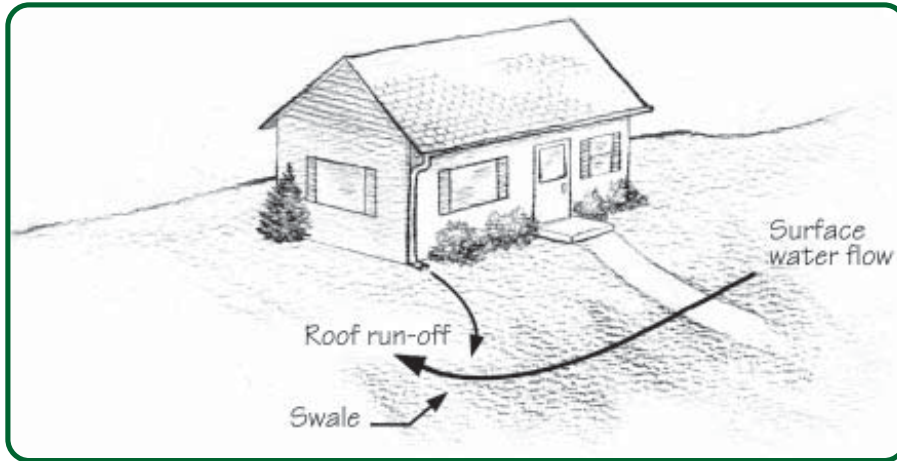

Figure 3.2 - Site Grading and Surface Drainage

3.2.3 Recommendation #3: Foundation Construction

Foundation options generally include basement, slab-on-grade, crawl space, or a mix of these foundation types (e.g., split level construction). One thing is common in all foundation construction: ground moisture will find its way “in” unless appropriate measures are taken. An important measure to include is a ground vapor barrier under all basement, slab-on-grade, or crawl space construction. This will eliminate (or suitably minimize) a large potential water vapor source to a house that can result in or aggravate above-ground

moisture vapor problems (see Chapter 4). The ground vapor barrier should be placed directly below and immediately prior to pouring the concrete slab to avoid damage during construction. Second, some method of removing ground water from around the foundation is recommended in all but the driest and most well-drained site conditions.

Typical basement construction practice and optional enhancements (i.e., polyethylene sheeting) for particularly wet sites are illustrated in Figure 3.3. However, “water proofing” is not meant to resist

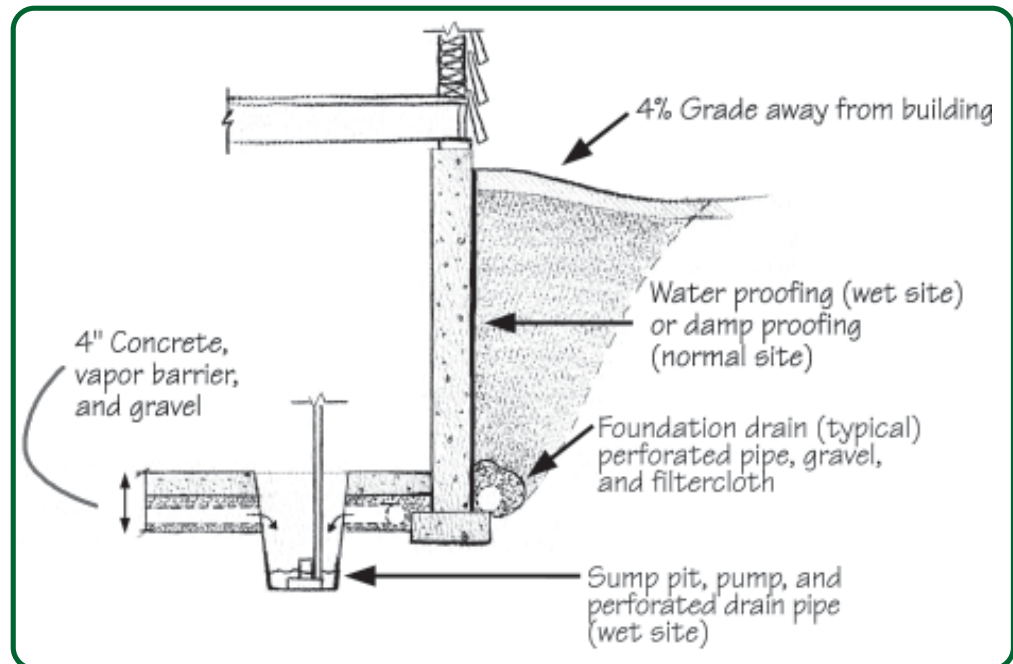

Figure 3.3 - Basement Construction and Optional Enhancements for Wet Site Conditions

water from flooding or a high water table. It should be noted that concrete has a considerably lower vapor permeability (i.e., can stop water vapor better) than masonry. However, available data seems to suggest no significant difference between concrete and masonry relative to the potential for basement water problems in actual practice.

For slab-on-grade and crawlspace foundations, moisture protection usually involves placing the building on a slight “mound” relative to the surrounding site. The use of a gravel layer under the slab or on the crawlspace floor is considered optional for mounded foundations, however, a vapor barrier should always be used. If the site is properly graded, a perimeter drain system is unnecessary in mounded foundation systems.

3.2.4 Recommendation #4: Frost Protection

Foundations are conventionally protected from frost (i.e., heave), by placing footings below a locally prescribed frost depth. An alternative in northern climates is the Frost Protected Shallow Foundation technology which offers the benefits of frost protection, energy efficiency, warmer slab edge temperatures (reduced condensation potential and improved

comfort), and material savings. This technology uses the heat generated within a building and stored in the ground to raise the frost depth around the structure, allowing for reduced-depth footings. A typical frost protected shallow foundation detail is shown in Figure 3.4. The technology and concept can be used to protect a variety of foundation types and site structures from frost heave. Refer to *Design Guide for Frost-Protected Shallow Foundations* (NAHB Research Center, 1996) for additional design and construction guidance.

It should be noted that current building codes prohibit the use of foundation insulation in areas with “heavy” termite infestation probability (i.e., southeastern United States). The foam can create a “hidden pathway” for termite access to wood building materials. Refer to Chapter 6 for methods to deter termite infestation.

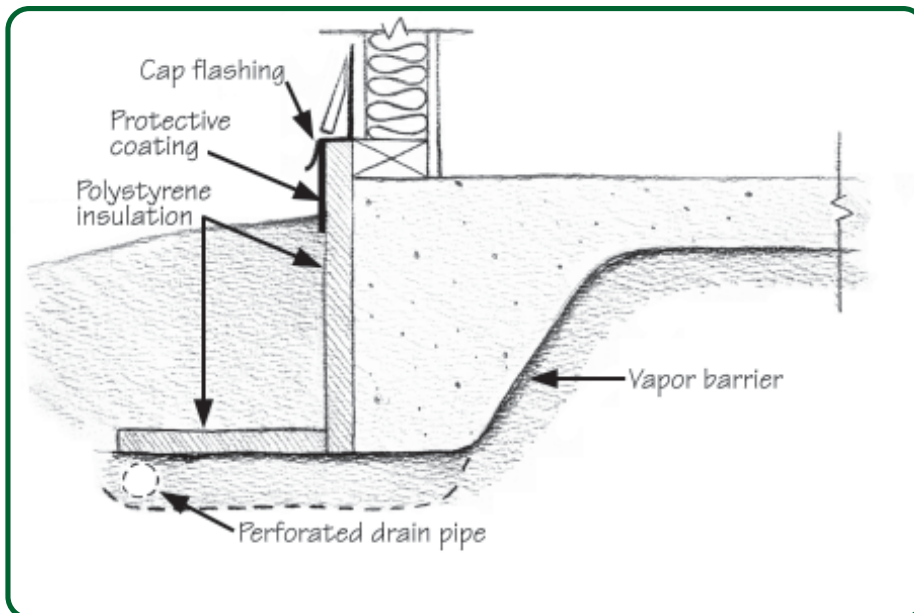

Figure 3.4 - Typical Frost-Protected Shallow Foundation with Perimeter Drain

CHAPTER 4 - Rain and Water Vapor

4.1 General

The most common and disastrous durability problems are frequently related to bulk moisture or rain penetrating a building's exterior envelope without any opportunity to drain or dry out rapidly. If rain penetration occurs repetitively and continues undetected or uncorrected, it can cause wood framing to rot, mold to grow, and steel to corrode. In fact, particularly bad cases of this type of problem have resulted in severely rotted wood frame homes within the period of a couple of years. However, most rain penetration problems can be isolated to inadequate detailing around windows and door openings and similar penetrations through the building envelope.

The objective of designing a weather barrier system is pure and simple—keep rain water away from vulnerable structural materials and interior finishes. Keeping these components dry will maintain a building's structural integrity and help prevent moisture-related problems like mold. Within this guide, “weather barrier” is a general term for a combination of materials used as a system that protects the building from external sources of moisture.

Important related issues are water vapor diffusion and drying potential. These issues are considered in tandem since they are practically inseparable design issues, creating the need to have an integrated design approach (i.e., one that adequately considers all factors and their potential impact on durability).

Some of the information presented in this chapter is generic in nature and will apply to most house designs (e.g., overhangs), while other recommendations are geared more towards specific configurations like vinyl or wood siding installed over wood sheathing. The Rules of Thumb listed in the sidebar to the right and the recommendations in this chapter should help to address the durability and performance issues related to liquid moisture (rain), perhaps the most significant durability factor.

4.2 Recommended Practices

Building walls are subject to water penetration and repeated wetting depending on their exposure, the climate, and the integrity of the siding system. While you can't change the climate in which you build, it *is* possible to improve the shielding of walls and to design walls that are appropriate for “imperfect” (i.e., leaky) siding systems.

4.2.1 Recommendation #1: Roof Overhangs

Figure 4.1 illustrates the frequency of building walls having moisture penetration problems in a particularly moist, cool climate (British Columbia) as a function of roof overhang length. The shielding effect of roof overhangs is illustrated in Figure 4.2. Note that a roof overhang's impact will depend on the climate (Figure 4.3) and type of construction protected. The potential for wind-driven rain should also be considered. The climate index map of Figure 4.3 does not directly account for wind-driven rain—

RULES OF THUMB

- Liquid water or rain obeys the following rules with respect to movement:
 - Gravity - water runs downhill
 - Capillary - water is attracted into small cracks due to capillary action or surface tension
 - Wind - wind can drive rain into places it would not otherwise go and create building interior and exterior pressure differentials that move it uphill, breaking the first rule (gravity)
- NO wall or roof covering is perfectly waterproof, especially considering that there will be wall openings, roof penetrations, and other materials that compromise even the “waterproof” materials—particularly in view of the effects of time.
- Avoid depending on caulk as a primary barrier to moisture penetration (i.e., use flashing).

a condition that varies with local climate or site exposure. Some important considerations regarding roof overhangs include:

- Roof overhangs protect exterior walls and foundations from excessive wetting by rain water—the culprit in many moisture problems in residential buildings.
- Just as the safety factor is important to providing for a reasonable structural design that accounts for foreseen events and unexpected extremes, so is the roof overhang to those interested in durable wood-frame building construction.
- The width of roof overhang to use depends on a variety of factors, including construction cost, wall type below, amount of windows and doors exposed, and the height of the wall. Recommended overhang widths are provided in Table 4.1 for typical conditions.
- Greater flexibility in architectural design with respect to the use (or non-use) of overhangs for rain water protection is afforded in more arid climate conditions; in other areas there are significant durability trade-offs (see Figure 4.1).
- In moist climates with significant rainfall, liberal use of overhangs is recommended.
- Roof overhangs also provide durability and energy benefits in terms of solar radiation (see Section 5.2).

In Table 4.1, the recommended overhang widths are given with the assumptions that: all walls have a properly constructed weather barrier, roofs are adequately guttered, and normal maintenance of exterior will occur. For overhangs protecting more than two-story walls with exposed windows and doors, larger overhangs should be considered. Rake (gable end) overhangs also deserve special consideration because more costly “outrigger” framing methods will be required for overhangs exceeding about 12 inches in width and the appearance may not be acceptable to some home buyers. Also, for sites subject to frequent wind-driven rain, larger overhangs and drainage plane techniques that include an air space behind the siding should be considered (see Section 4.2.3). For non decay-resistant wood sidings and trim (as for windows and door casings), greater overhangs and porch roofs are recommended.

4.2.2 Recommendation #2: Roof Gutters and Down-spouts

Properly designed roof gutters reduce the amount and frequency of roof run-off water that wets above-grade walls or the foundation. A list of recommendations and a rule-of-thumb design approach are presented below to help in the proper use of gutters. Figure 4.4 illustrates a typical gutter installation and components.

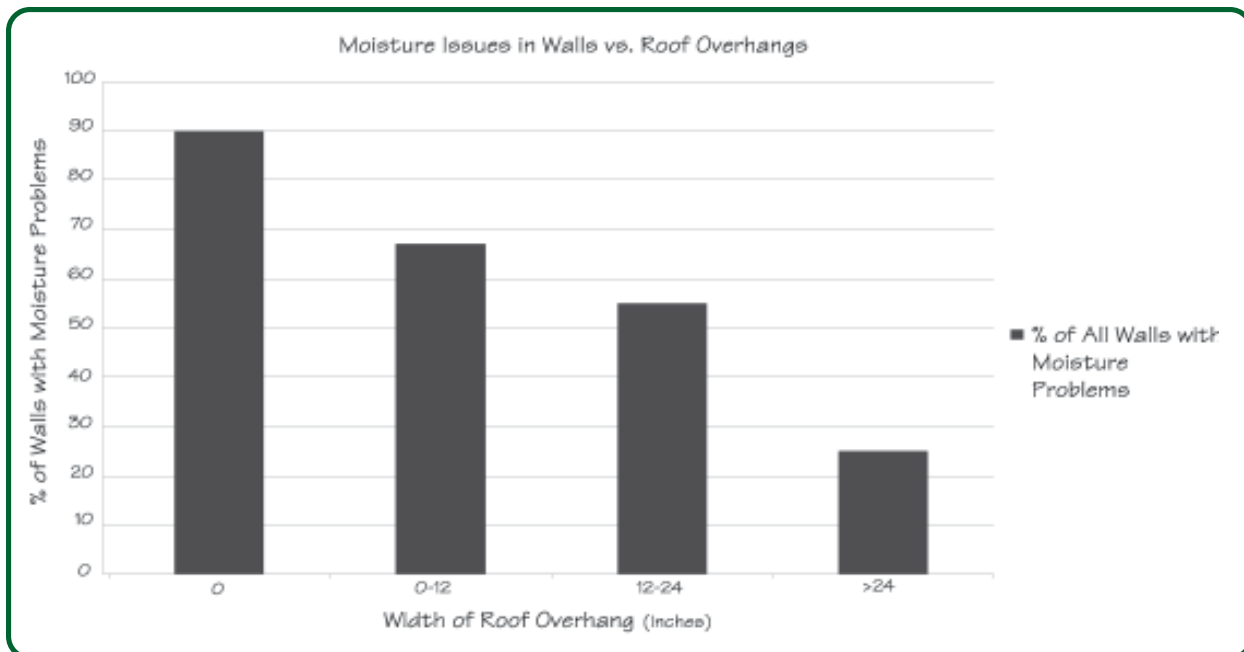

Figure 4.1 - Frequency of Moisture Problems in Walls of Selected Buildings in a Moist, Cool Climate
(Climate Index of approximately 70 based on Figure 4.3)

Source: Morrison Hershfield Limited, *Survey of Building Envelope Failures in the Coastal Climate of British Columbia*, Canada Mortgage and Housing Corporation, Burnaby, BC, Canada, 1996. Figure is based on a selection of 46 buildings of up to eight years old, three to four stories, wood-frame, with various wall claddings. Fifty percent of walls with problems used direct-applied stucco cladding over building paper and oriented strand board (OSB) wood panels.

TABLE 4.1 - RECOMMENDED MINIMUM ROOF OVERHANG WIDTHS FOR ONE- AND TWO-STORY WOOD FRAME BUILDINGS*

Climate Index (Figure 4.3)	Eave Overhang (Inches)	Rake Overhang (Inches)
Less than 20	N/A	N/A
21 to 40	12	12
41 to 70	18	12
More than 70	24 or more	12 or more

Source: Modification of *Prevention and Control of Decay in Homes* by Arthur F. Verrall and Terry L. Amburgey, prepared for the U.S. Department of Agriculture and U.S. Department of Housing and Urban Development, Washington, DC, 1978.
 *Table based on typical 2-story home with vinyl or similar lap siding. Larger overhangs should be considered for taller buildings or wall systems susceptible to water penetration and rot.

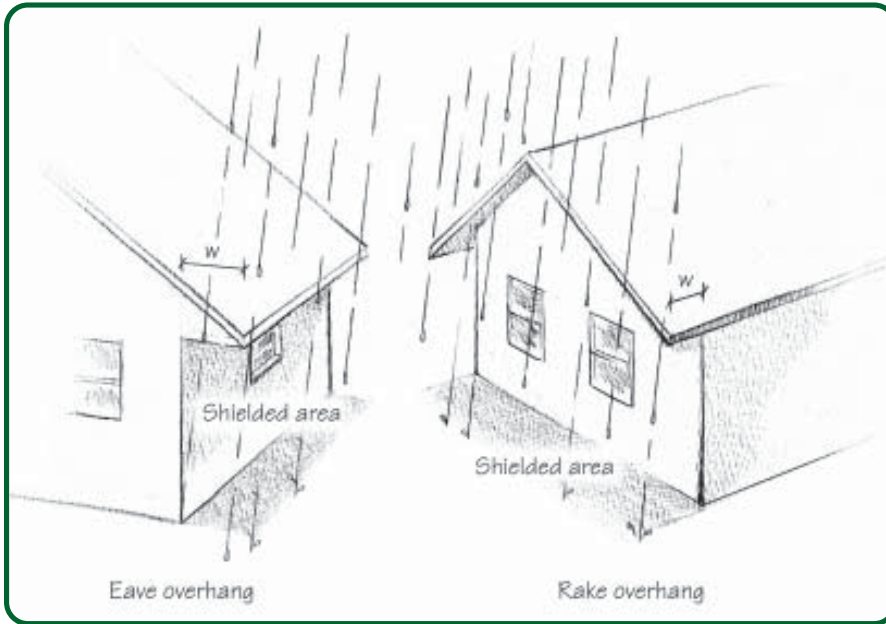

Figure 4.2 - Roof Overhangs

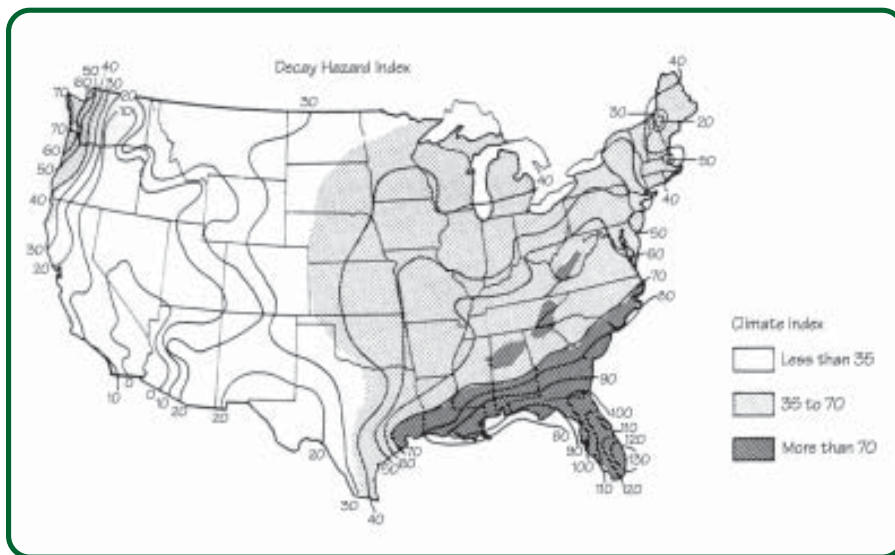

Figure 4.3 - Climate Index Map Based on Wood Decay Potential

Prepared by the U.S. Weather Bureau.

Source: Theodore C. Scheffer, "A climate index for estimating potential for decay in wood structures above ground," *Forest Products Journal*, Vol. 21, No. 13, October 1971.

Site specific indices may be determined using the following formula, where T is the monthly mean temperature ($^{\circ}F$), D is the mean number of days in the month with 0.01 inch or more of precipitation, and Σ is the summation of products $(T-35)(D-3)$ for respective months of the year.

$$\text{Climate Index} = \frac{\sum_{\text{Jan}}^{\text{Dec}} [(T - 35)(D - 3)]}{30}$$

NOTE: Roof overhangs also provide protection from sunlight; refer to Chapter 5 for advice on using overhangs to minimize the impact of UV radiation. Roof overhangs in hurricane-prone locales may require additional anchorage of the roof.

- Downspouts that discharge to the surface should do so at least two feet outward from the building. Splash blocks or plastic corrugated pipe are recommended to prevent erosion and to give further extension of discharge water away from the foundation, particularly for downspouts located at inside corners of buildings.
- Downspouts that discharge water below grade should do so into non-perforated corrugated or smooth plastic pipe. The pipe should be run underground to a suitable outfall. Do not connect the gutter drain pipe to the perforated foundation drain pipe, this practice will soak the foundation.
- Gutters and downspouts should be resistant to corrosion and abrasion from flowing water; material choices include aluminum (most popular), vinyl or plastic, copper, and coated metal (baked enamel or galvanized).
- Use a gutter splash shield at inside corners (i.e., valleys) where fast moving water in a roof valley may “overshoot” the gutter.
- Gutters, downspouts, and splash blocks must be cleaned and properly maintained by the homeowner.

Sizing of Gutters and Downspouts

Generally, a standard 5-inch deep gutter and 2-inch by 3-inch downspouts are adequate for most homes in most climate conditions in the United States. However, the following simplified sizing method may help to avoid problems when unique situations are encountered. An example is provided on page 20.

Step 1: Determine the horizontal projected roof area to be served by the gutter and multiply by the roof pitch factor from Table 4.2.

Step 2: Estimate the design rainfall intensity (see map in Figure 4.5).

Step 3: Divide selected gutter capacity (Table 4.3) by the rainfall intensity estimated in Step 2 to determine the maximum roof area served.

Step 4: Size downspouts and space along gutter in accordance with factored roof area calculated in Step 1 for the selected gutter size and type. As a rule of thumb, one square inch of down-spout cross section can serve 100 square feet of roof area (i.e., 2”x3” downspout for 600 ft²; 3”x4” downspout for 1,200 ft²).

(Source: “All About Gutters” by Andy Engel, *Fine Homebuilding*, August/September 1999).

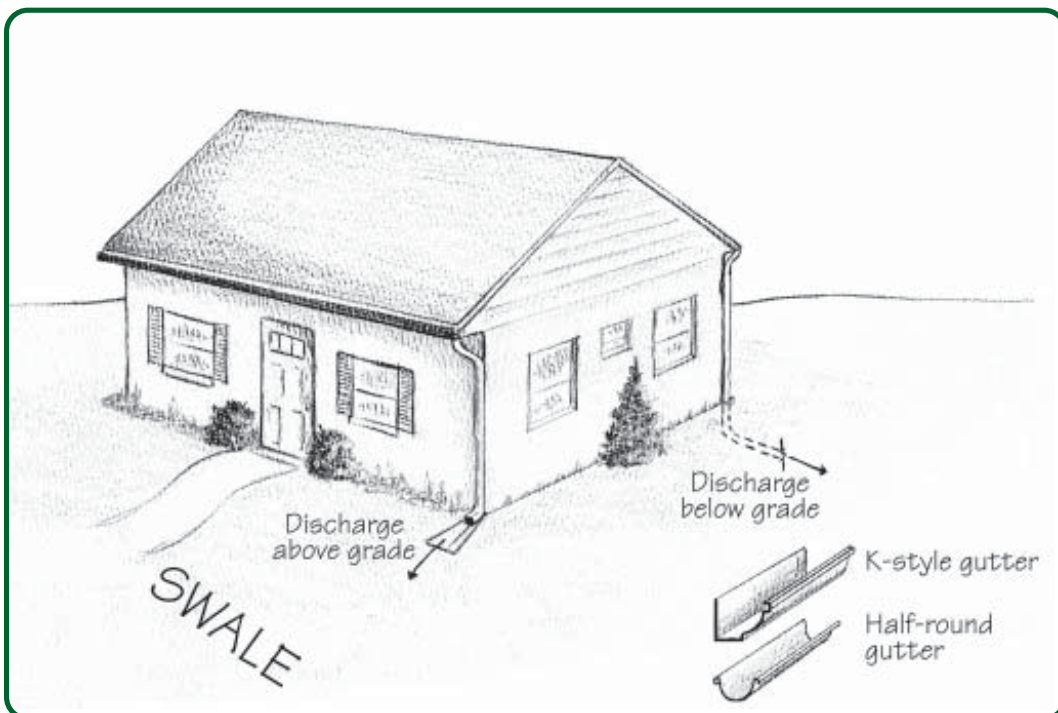

Figure 4.4 - Roof Gutters and Discharge Methods

Roof Pitch	Factor
Flat to 3:12	1
4:12 to 5:12	1.05
6:12 to 8:12	1.1
9:12 to 11:12	1.2
12:12	1.3

Gutter Shape	Gutter Size	
	5-inch depth	6-inch depth
K-style	5,520 ft ²	7,960 ft ²
Half-round	2,500 ft ²	3,840 ft ²

Note:
 1. Values based on a nearly level gutter. Increasing gutter to a slope of 1/16 inch per foot, multiply values by 1.1 or by 1.3 for 1/8 inch per foot slope.

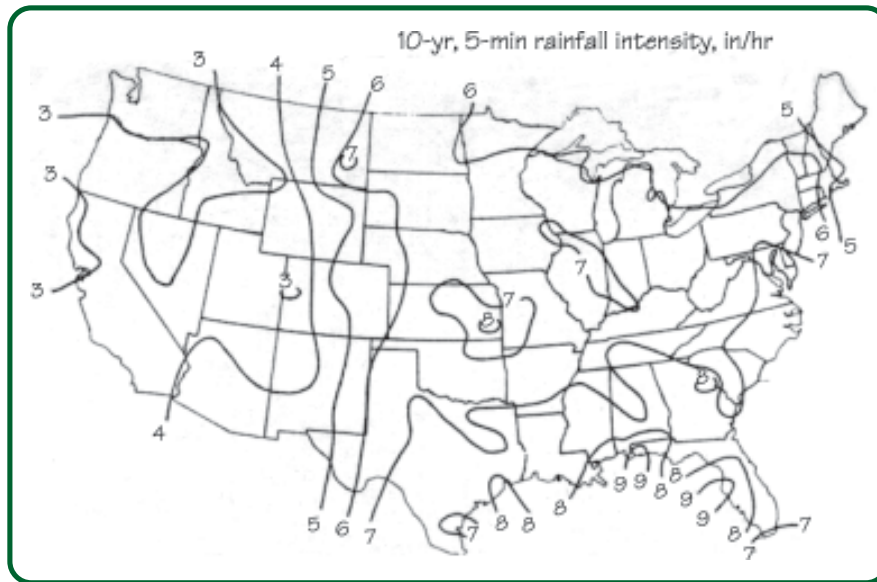

Figure 4.5 - Rainfall Intensity Map of the United States

4.2.3 Recommendation #3: Weather Barrier Construction

Weather barrier is a broad term for a combination of materials including siding, roofing, flashing, sheathing, finishes, drainage plane, and vapor retarders that, as a system, exhibit water retarding and vapor retarding characteristics and may also possess thermal insulation and air infiltration barrier characteristics.

Drainage Planes

The primary goal in protecting a building wall is to shield the wall from bulk moisture through the use of overhangs, gutters, siding, and opening protection (i.e., flashing or overhangs). As a second line of defense, a drainage plane provides a way out to drain any moisture that penetrates the wall's primary line of defenses (i.e., rain water that gets behind cladding). In less severe climates (low climate index - see Figure 4.3) or when a wall is otherwise protected from rain, the use of a specially detailed

DRAINAGE, VAPOR, AND AIR

*Drainage planes do just what their name implies—they drain away liquid water that gets past siding or exterior cladding. **But** that's not all they do. Drainage planes made from building paper or housewrap can affect how water vapor passes (or tries to pass) through a wall. Table 4.4 gives recommendations on this. Drainage planes like housewrap may also serve as air barriers, a boundary around the house that reduces air infiltration. Even if housewrap is only used as an air barrier to cut down air infiltration, it's crucial to understand that it will also collect and channel liquid water that gets past the wall's cladding—like it or not. Housewrap Recommendations (page 25) gives guidance on this issue.*

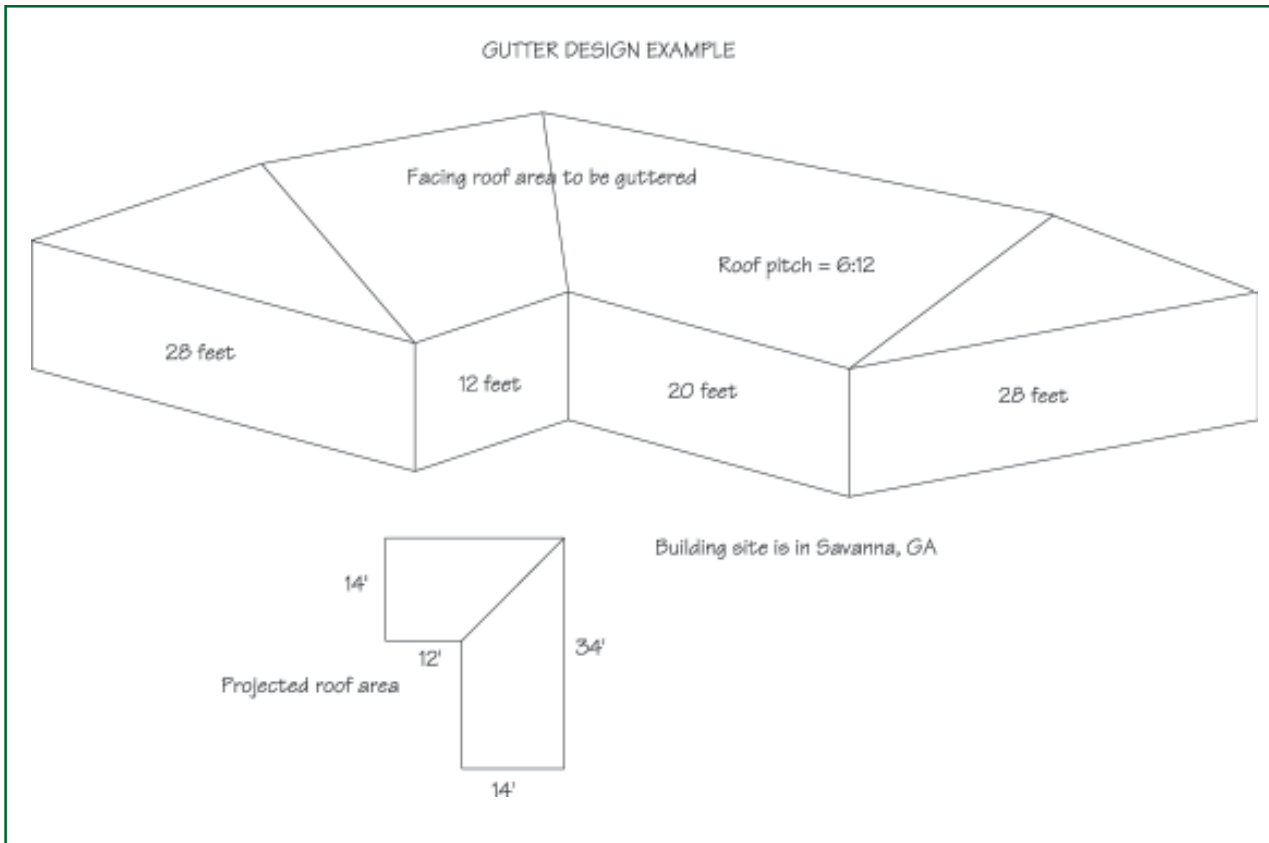
**Step 1**

Horizontal projected roof area = $(14' \times 12') + (14' \times 34') = 644 \text{ ft}^2$

Factored area = $(1.1)(644 \text{ ft}^2) = 708 \text{ ft}^2$

Step 2

From rainfall intensity map, Figure 4.5, the estimated rainfall intensity is 7 in/hr.

Step 3

Select a K-style gutter with a 5-inch-depth and a 5,520 ft^2 - in/hr rating from Table 4.3.

Divide by rainfall intensity as follows: $(5,520 \text{ ft}^2 * \text{in/hr}) / (7 \text{ in/hr}) = 788 \text{ ft}^2 > 708 \text{ ft}^2$ OK

Therefore, the gutter is capable of serving this area.

Step 4

A single 2" x 3" downspout is not large enough (i.e., $600 \text{ ft}^2 < 708 \text{ ft}^2$). Therefore, use one 3" x 4" downspout (at one of the outside corners) or two 2" x 3" downspouts (one at each outside corner). Be sure the gutter is sloped evenly from near its midpoint toward each downspout so that a nearly equal roof area is served by each.

barrier may have little durability benefit. However, for wall systems that are not extremely well-protected from bulk moisture, that are in wind-driven rain climates, or that are sensitive to wetting, the use of a secondary drainage plane should be employed.

Figure 4.6 shows a typical wall system with siding. It's safe to assume that all types of wall coverings (siding, brick, masonry) are imperfect and will leak at some point—some more than others. Therefore, it is important to consider the use of a drainage plane behind the siding material. In some climates, like arid regions with infrequent rain events, a drainage plane may be unnecessary or of very little use. Rain water that does penetrate wood-framed wall systems in these regions can take advantage of

wood's capacity to temporarily store moisture, and the wall can dry out via air movement and vapor diffusion once arid outdoor conditions resume (see below for more about Drying Potential).

It may be advisable to use an air space between siding and a drainage plane if:

- A house is in a particularly severe climate (frequent rainfall or wind-driven rain) such as coastal regions subject to hurricanes; and
- Moisture-sensitive siding materials (e.g., wood) are used.

This air space (e.g., use of furring in Figure 4.6), in conjunction with vents (and general air leaks) that allow air to move behind the exterior siding or cladding, provides pressure equalization and creates

a capillary break between the back of the siding and the drainage plane. These features will help to reduce the amount of rain water that penetrates behind the exterior cladding and promote better drying potential for the siding and the inner wall. However, creating this space using furring strips applied on top of the drainage plane material must account for the effect on details for flashing and finishing around wall openings such as windows and doors.

Depending on the wall design approach and the climate, a drainage plane needs to exhibit certain characteristics for allowing or retarding the transmission of water vapor, while still rejecting the passage of liquid water like rain. Table 4.4 provides guidance in selecting appropriate wall drainage plane characteristics for various climates. The table considers both how well certain materials reject *liquid* water and how readily they allow water *vapor* to pass through them. This is an important issue that affects the drying potential of walls.

The properties of materials that can be used for drainage planes are found in Table 4.5. In all applications, any material used as a drainage plane should have high resistance to liquid water penetration.

Vapor Retarders

While it's obvious that the drainage plane of a wall must be located on the outer face of a wall or just behind the siding, it is just as important to remember one rule of thumb related to moisture vapor transport in walls. Namely, any vapor retarder must be located on the warm-in-winter side of the wall (i.e., inside) in all climates except hot/humid climate where it should be placed on the warm-in-summer side of the wall (i.e., outside) if one is used at all.

Water vapor in the air is transported by vapor diffusion and bulk air movement. Vapor retarders are intended to restrict the transmission of water vapor via diffusion. A common application of a vapor

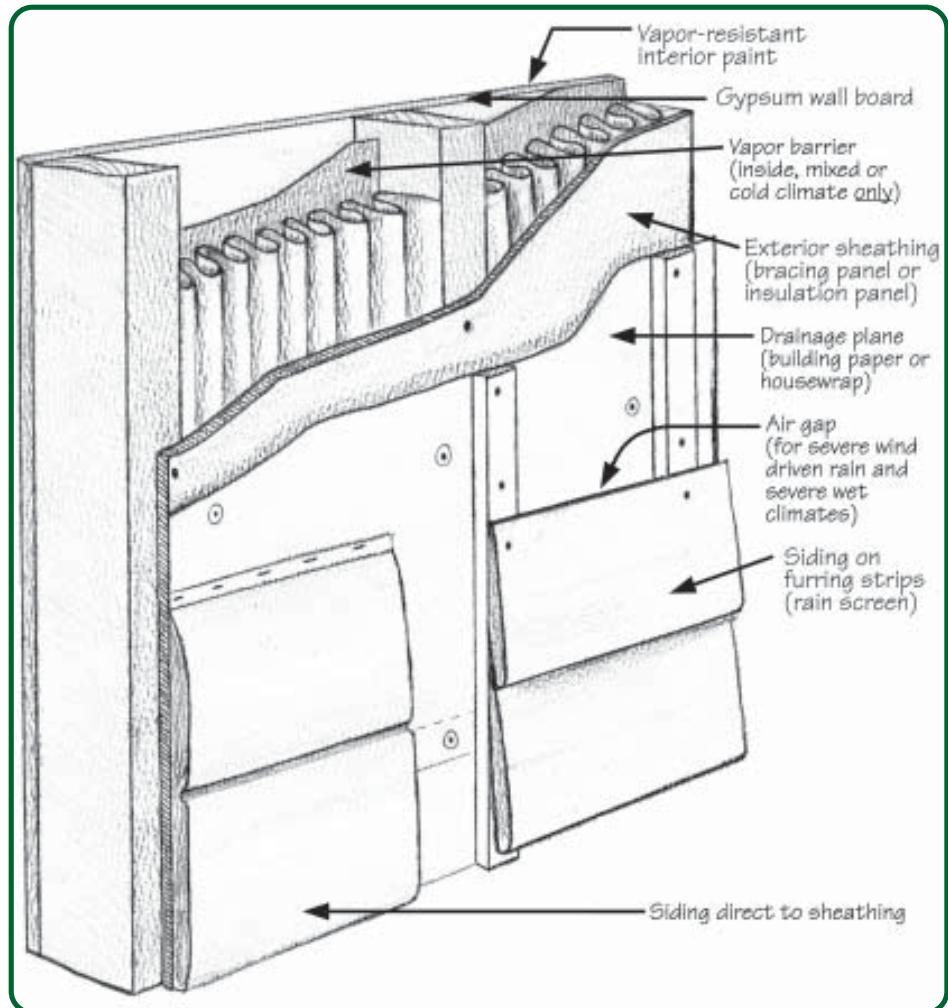

Figure 4.6 - Weather Barrier Construction

retarder would be the use of a polyethylene sheet or kraft paper between drywall and framing of exterior walls in cold climates. However, bulk air movement (i.e., air leakage containing water vapor) is far more significant in terms of the amount of water vapor that can be transmitted, moving roughly 10 to 100 times more moisture than diffusion. This being said, the vapor retarder can still play an important role in controlling the movement of water vapor in walls, particularly in very cold climates.

Table 4.6 provides guidance on appropriate locations and characteristics of vapor retarders for various climates. When using a vapor retarder, it must be installed on the correct side of the wall or ceiling. Otherwise, condensation will form and cause sudden or eventual damage. Also, some older codes established minimum perm ratios for the inner and outer faces of a wall (e.g., a minimum outer face to inner face perm ratio of 5:1 in cold climates to facilitate drying to the outside). Design rules like this

one point out that many materials can and will affect vapor diffusion even if they are not classified as vapor retarders. This point, and the fact that air movement can also move large amounts of water vapor, are equally important to designing a wall to handle water vapor.

Building Paper vs. Housewrap

The question “should I use building paper or housewrap” is often asked. And for certain climates in Table 4.4, the question remains. This leads to a discussion of the two product categories and their relative performance characteristics.

Any discussion of this sort should be prefaced by recognizing that *neither* product will work effectively if not installed correctly – and could even do serious harm to a building’s durability if used incorrectly.

TABLE 4.4 - RECOMMENDED DRAINAGE PLANE CHARACTERISTICS FOR EXTERIOR WALLS IN VARIOUS CLIMATE CONDITIONS

Climate Condition ¹	Drainage Plane Characteristic		Recommended Product Type
	Liquid Water Resistance	Water Vapor Permeability (low = little vapor passes; high = vapor passes easily)	
Hot & Humid Climate Index >70 HDD < 2,500	High	Moderate to Low ²	15# tarred felt
Mixed Climate Index >20 2,500 < HDD < 6,000	High	High to Moderate	15# tarred felt or housewrap
Cold HDD > 6,000	High	High ³	15# tarred felt or housewrap
Dry Climate Index < 20	N/A	N/A ⁴	optional

Notes:

¹HDD refers to Heating Degree Days relative to 65°F (see Figure 4.7). See Figure 4.3 for Climate Index.

²HOT/HUMID CLIMATE CONCERNS: The drying potential of hot/humid climates is through the interior wall, and the layer of lowest vapor permeability (i.e., vapor retarder) must be located to the outside of the wall. If a drainage plane material is used with a low permeability (i.e., polyethylene sheet or foam panel insulation) then it is imperative that a high permeability is achieved on the inside face of the wall (which may affect interior finish selection such as paint type and limit use of materials such as wall paper – see Table 4.5 below). In addition, it becomes more important in hot/humid climates to carefully size HVAC systems so that they operate without “short cycling.” Again, moisture entry to the building and condensation potential can be significantly reduced by use of a foundation/ground vapor barrier (Chapter 3).

³COLD CLIMATE ALTERNATIVES AND CONCERNS: In this case, energy efficiency can be a conflicting objective to the table’s recommendation. For instance, interest in energy efficiency (or code mandated minimum R-values) often leads builders in cold climates to place an impervious layer of insulation (i.e., polystyrene or foil-faced polyisocyanurate) on the outer surface of the wall. These materials generally have a low permeability to water vapor (see Table 4.5). Since vapor barriers are often required on interior (warm-in-winter side) of walls in cold climates, this can create a situation where a wall has low drying potential. Therefore, this approach should be used with caution in areas that are cold but are also subject to substantial rainfall which may penetrate an improperly installed weather barrier or one that fails to maintain its resistance to liquid water penetration over time. In addition, it becomes critical to seal key leakage areas judiciously to prevent leakage of moist, warm indoor air into the wall cavity where it may condense. Condensation in the wall cavity can also be prevented by controlling indoor air humidity. At a minimum, interior moisture sources should be addressed by using bathroom and kitchen exhaust fans to remove the significant moisture that is produced in these areas of the building. Finally, moisture entering the building/walls from the ground should be minimized by the use of foundation and ground vapor barriers (see Chapter 3).

⁴No drainage plane is required for durability purposes in a dry climate, although care should be taken to seal major air-leakage points for sake of keeping infiltration air out of wall assemblies.

Housewrap products are sometimes viewed solely as air barriers – a product that will reduce air infiltration and do nothing else. Wrong. As discussed in Table 4.4, housewrap products also block liquid water that gets past siding, making this type of product useful for a drainage plane.

And in fact, housewraps will act to collect and channel liquid water whether the installer intends for them to do so or not. This can lead to trouble if housewrap is installed in a manner (e.g., not lapped correctly, drains water behind windows) that doesn't allow for channeling water out of a wall system. So the lesson is: housewraps are not just air barrier products, they can – and should be – used as drainage planes as well. Their vapor diffusion characteristics aren't sufficient to allow quick drying should misinstallation result in bulk water penetration.

PLUG UP THE LEAKS

In all cases, major air leakage points through the building envelope should be sealed to limit the flow of air, heat, and moisture. Places to air seal include areas around door and window frames, attic hatches, kneewalls, HVAC chases, and electrical and plumbing penetrations into attics.

TABLE 4.5 - DRAINAGE PLANE AND VAPOR RETARDER MATERIAL PROPERTIES^{1,2}

Material	Weight or Thickness	Permeance, perms ³ (vapor retarder = 1 perm or less)			Liquid Water Loss ⁵
		Dry-cup Method	Wet-cup Method	Other	
15# asphalt felt	14 lb/100 sf	1.0	5.6	—	30%
15# tar felt	14 lb/100 sf	4.0	18.2 ⁴	—	—
Building wraps (6 brands)	—	5.0 - 200.0	5.0 - 200.0	—	0 to 80% ⁶
Blanket Insul., asphalt coated paper	6.2lb/100 sf	0.4	0.6 - 4.2	—	—
6mil polyethylene	0.006 in	0.06	—	—	—
Aluminum foil	0.001 in	0.0	—	—	—
Gypsum board	3/8 in	—	50.0	—	—
Plywood (interior glue)	1/4 in	—	1.9	—	—
Block	8 in	—	2.4	—	—
Brick	4 in	—	0.8	—	—
Concrete	4 in	—	0.8	—	—
Polystyrene, expanded board	1 in	2.0 - 5.8	—	—	—
Polystyrene, extruded board	1 in	1.2	—	—	—
Vapor retarder paint	0.0031 in	—	0.5	—	—
Primer sealer paint	0.0012 in	—	6.3	—	—
Exterior acrylic house and trim paint	0.0017 in	—	5.5	—	—

Notes:

¹These values only relate to performance in standardized and constant test conditions and do not necessarily represent actual behavior under actual conditions of use. Leakage as a result of discontinuities and other conditions experienced in construction of buildings may easily alter, by a factor of 2 or more, the overall or localized performance of a vapor retarder in comparison of these standardized values. Therefore, these values can be used for indexing purposes only.

²Differences in perm ratings between dry-cup, wet-cup, and other test methods are substantial and any cross comparison should be made on the bases of similar test methods and conditions. Manufacturer data should be consulted when available.

³Usually tested according to ASTM E 96.

⁴Value can vary to more than 60 perm in 95% relative humidity test conditions.

⁵Tested using AATCC 127 test method modified to a 3.5 inch head for 2-hour duration (University of Massachusetts, Building Materials and Wood Technology, Paul Fisette, as reported on www.umass.edu/bmatwt/weather_barriers.html, October 1999).

⁶Of six brands tested, R-Wrap and Tyvek received the best possible rating of 0 water loss (liquid water transmission). However, when these products were subjected to soapy water and a cedar extractives water solution, the loss rates increased slightly.

In addition to air barrier and drainage plane functions, housewraps are designed to allow water vapor to diffuse through them. Housewraps should not be considered as vapor retarders. Research conducted by the University of Massachusetts (www.umass.edu/bmatwt/weather_barriers.html) examined 6 brands of housewrap and found permeability levels ranging from 5 to 200 perms.

This research also stated that the housewraps appeared to have their ability to reject liquid water degraded somewhat by the use of soapy water (from power washing) and, to a lesser degree, water laden with a cedar extractive.

On the other hand, 15# felt paper has a lower perm rating (~ 4 perms at low relative humidity) than housewrap products, enhancing its ability to limit

TABLE 4.6 - RECOMMENDED VAPOR RETARDER CHARACTERISTICS FOR BUILDING EXTERIORS OR INTERIORS IN VARIOUS CLIMATE CONDITIONS

Climate Condition ¹	Location of Vapor Retarders	Water Vapor Permeability ² (low = little vapor passes high = vapor passes easily)	Recommended Product Type ²
Hot and Humid HDD < 2,500	Outer side of wall	Low to moderate (see Table 4.4, Drainage Plane) ³	15# tarred felt
	Foundation (slab, crawl, or basement)	Low	6 mil polyethylene plastic sheet on ground
	Attic & Cathedral Roof	High	None
Mixed 2,500 < HDD < 6,000	Inner side of wall	Moderate (2,500 HDD) to Low (6,000 HDD)	Kraft paper on batts or vapor retarder paint on interior
	Foundation (slab, crawl, or basement)	Low	6 mil polyethylene plastic sheet on ground
	Attic & Cathedral Roof (ceiling side) ⁴	High (2,500 HDD) to Moderate (6,000 HDD)	None to Kraft paper on batts (6,000 HDD)
Cold HDD > 6,000	Inner side of wall	Low	3 mil polyethylene or vapor retarder paint on interior
	Foundation (slab, crawl, or basement)	Low	6 mil polyethylene on ground
	Attic & Cathedral Roof (ceiling side) ⁴	Moderate (6,000 HDD) to Low (9,000 HDD)	Kraft paper on batts to 3 mil polyethylene or vapor retarder paint on interior

Notes:

¹HDD refers to Heating Degree Days relative to 65°F (see Figure 4.7).

²These recommendations are based on both the material properties (perms) and how they are used. A product that is not applied continuously over a surface (e.g., kraft faced batts in a ceiling) will allow more vapor to pass than a continuous layer.

³Because it is equally important to ensure that the interior surface of a wall has a high permeability finish, select paint with high permeability and avoid finishes such as vinyl wall paper that will act as a vapor barrier. *Prevention and Control of Decay in Homes*, USDA/HUD, 1978, recommends that "In warm climates, walls and ceilings without vapor barriers are safer."

⁴Attic vapor barriers for hip and gable roofs, if used in mixed and cold climates, should be placed on the warm-in-winter side of the attic insulation. The same applies to cathedral ceilings.

vapor transmission through the wall (in either direction). This characteristic is a benefit in hot and humid regions and in designs where some resistance to vapor movement from outside to inside is desired (e.g. behind brick veneer or unsealed wood siding). While building paper is not usually viewed as an air barrier product, it can still be used in conjunction with other measures (e.g. caulk and foam sealants) to produce a wall system with reduced air infiltration.

So both products can shed liquid water. Housewrap tends to be more vapor permeable than building paper (check the perm rating for specific brands though), allowing water vapor to diffuse more easily; but neither product would be considered a vapor retarder even though both slow the movement of vapor to some degree. Housewrap can be used as an air barrier, whereas building paper would likely be used in tandem with other air sealing measures. These differences, as well as price, should be the basis for a choice when a decision needs to be made. But once more, keep in mind that *neither* type of product will perform the way it's supposed to if it's not properly installed and integrated with flashing of windows and doors (see Section 4.2.4 on flashing and housewrap installation).

Housewrap Recommendations

Housewraps are relatively new materials that serve a dual role as a secondary “weather resistant” barrier and an air barrier. However, this dual role of

building materials has been known for some time for materials such as building paper or “tar paper” (USDHEW, 1931). Even lath and plaster has been classified as an effective air barrier—a finding that also stands for its modern day counterpart, gypsum wallboard. Of course, an air barrier is not a substitute for proper sealing of penetrations in the building envelope around windows, doors, utilities, and other leakage points.

Therefore, as with the application of building paper, housewraps should be viewed and installed with the main goal of serving as a secondary weather-resistant barrier (i.e. drainage plane). Like tar paper, the edges of housewrap should be lapped to provide a drainage pathway for water out of the wall. It is only necessary to tape lapped edges if some improvement in air-barrier performance is desired. However, building wraps are not all created equal in terms of their “breathability” and this additional sealing can affect the drying time of the wall system should it become inadvertently wetted by condensation or, more importantly, rain water (See Table 4.5). At wall penetrations, the housewrap should be properly detailed or flashed (See Section 4.2.4). In some cases, housewraps are installed *after* window and door installation (Figure 4.13), and manufacturer-recommended tapes must be used to seal the joints. While this practice is not uncommon, a preferred method is to install the building wrap prior to window and door installation and to additionally flash window and door heads as shown in Figure 4.12.

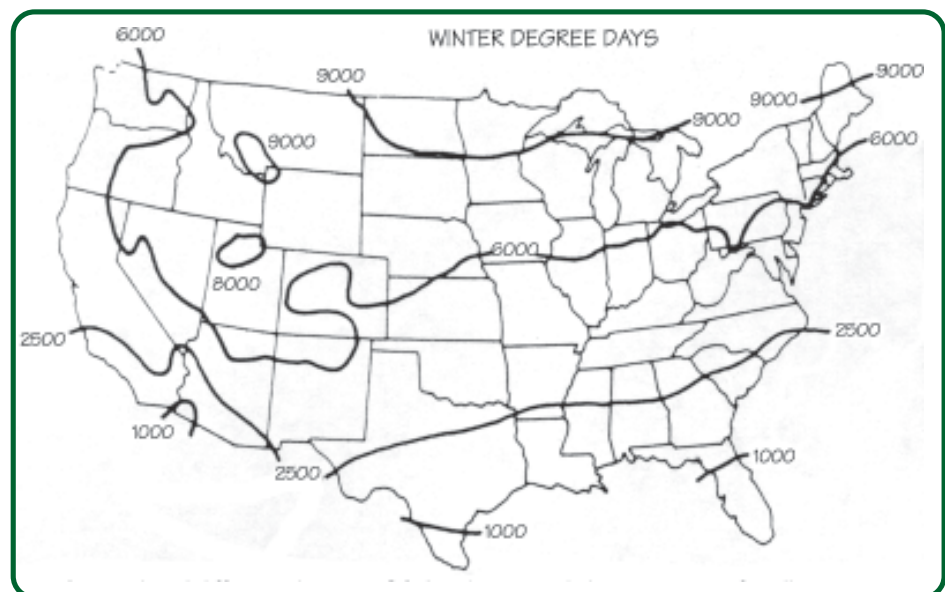

Figure 4.7 - Heating Degree Day (HDD) Map of the United States (65°F basis)

Drying Potential

Drying potential, the ability of a wall system to dry out after it is wetted, is important because it can compensate for conditions when water gets where it's not supposed to be. High drying potential will allow walls that are moist to dry out in a reasonable amount of time and limit the consequences. An ideal wall would be one that doesn't let any moisture in from interior vapor, exterior vapor, rain, snow, or ice. This would require a hermetically-sealed wall, which is not practical in residential construction. If this design approach of a "perfect" sealed wall is pursued and water does get into the wall, it will be trapped there and the results can be disastrous.

Therefore, it is imperative to make less than ideal materials work satisfactorily through careful design, careful construction, and an expectation that water will get into walls. Appropriate solutions will depend on climate conditions, the building use conditions, and common sense.

An ideal wall material acts as a storage medium, safely absorbing excess moisture and expelling it when the relative humidity decreases during periods of drying. Heavy masonry walls do this. To some degree, natural wood materials also exhibit this characteristic and create a beneficial "buffering effect" to counter periods where moisture would otherwise accumulate to unacceptable levels. This effect is part and parcel of the "breathing building" design approach and it serves as a safety factor against moisture problems, just like a roof overhang.

Materials such as concrete, masonry, and brick also exhibit a moisture storage or buffering capacity as do many contents of a home. This creates a lag effect that should be considered in building design and operation. For example, moisture levels in building materials tend to increase during warm summer months. As the weather cools in the fall, a moisture surplus exists because the expulsion of excess moisture lags in comparison to the rate of change in season temperatures.

Bear in mind that most building moisture problems are related to exterior moisture or rain. Moisture vapor and condensation is usually only a problem in extremely cold climates (upper Midwest and Alaska) or in extremely hot and humid climates, particularly when significant moisture sources exist within a home. For instance, a small house in a cold climate with high internal moisture loads (people, bathing, cooking), little natural or mechanical ventilation, and the lack of a suitable interior vapor retarder (i.e., between drywall and external wall framing) will likely experience moisture problems.

4.2.4 Recommendation #4: Proper Flashing

Flashing is perhaps one of the disappearing crafts in the world of modern construction and modern materials that seem to suggest simple installation, "no-worry" performance, and low maintenance. An emphasis on quick installations often comes at the expense of flashing.

Good flashing installations take time. But it's time well invested. So, if flashing is to be installed, it is best to invest the effort to make sure it's done right. In Figures 4.8 - 4.16 some typical but important flashing details are provided as models for correct installation techniques.

RULES OF THUMB AND TIPS

- *Flashing is necessary for proper drainage plane performance in walls and for roofing systems.*
 - *Most leakage problems are related to improper or insufficient flashing details or the absence of flashing.*
 - *All openings in exterior walls and roof penetrations must be flashed.*
 - *Caulks and sealants are generally not a suitable substitute for flashing.*
 - *Water runs downhill, so make sure flashing is appropriately layered with other flashings or the drainage plane material (i.e., tar, felt, or housewrap).*
 - *Water can be forced uphill by wind, so make sure that flashings have recommended width overlap.*
 - *Sometimes capillary action will draw water into joints between stepped flashing that is not sufficiently lapped or*
- that is placed on a low-pitch roof – take extra precaution in these situations.*
- *Avoid joint details that trap moisture and are hard to flash.*
 - *Treat end joints of exterior wood trim, railings, posts, etc. prior to painting; paint end joint prior to assembly of joints; if pre-treating, be sure the preservative treatment is approved for use with the type of paint or stain being used.*
 - *Minimize roof penetrations by use of ventless plumbing techniques, such as air admittance valves, side wall vents, and direct vented appliances (check with local code authority for approval).*
 - *Use large roof overhangs and porches, particularly above walls with numerous penetrations or complex window details.*

BASIC FLASHING MATERIALS AND TOOLS

- Flashing stock (coated aluminum, copper, lead, rubber, etc.)
- 15# felt paper
- Bituminous adhesive tape
- Utility knife
- Aviator snips or shears
- Metal brake (for accurate bending of custom metal flashing)

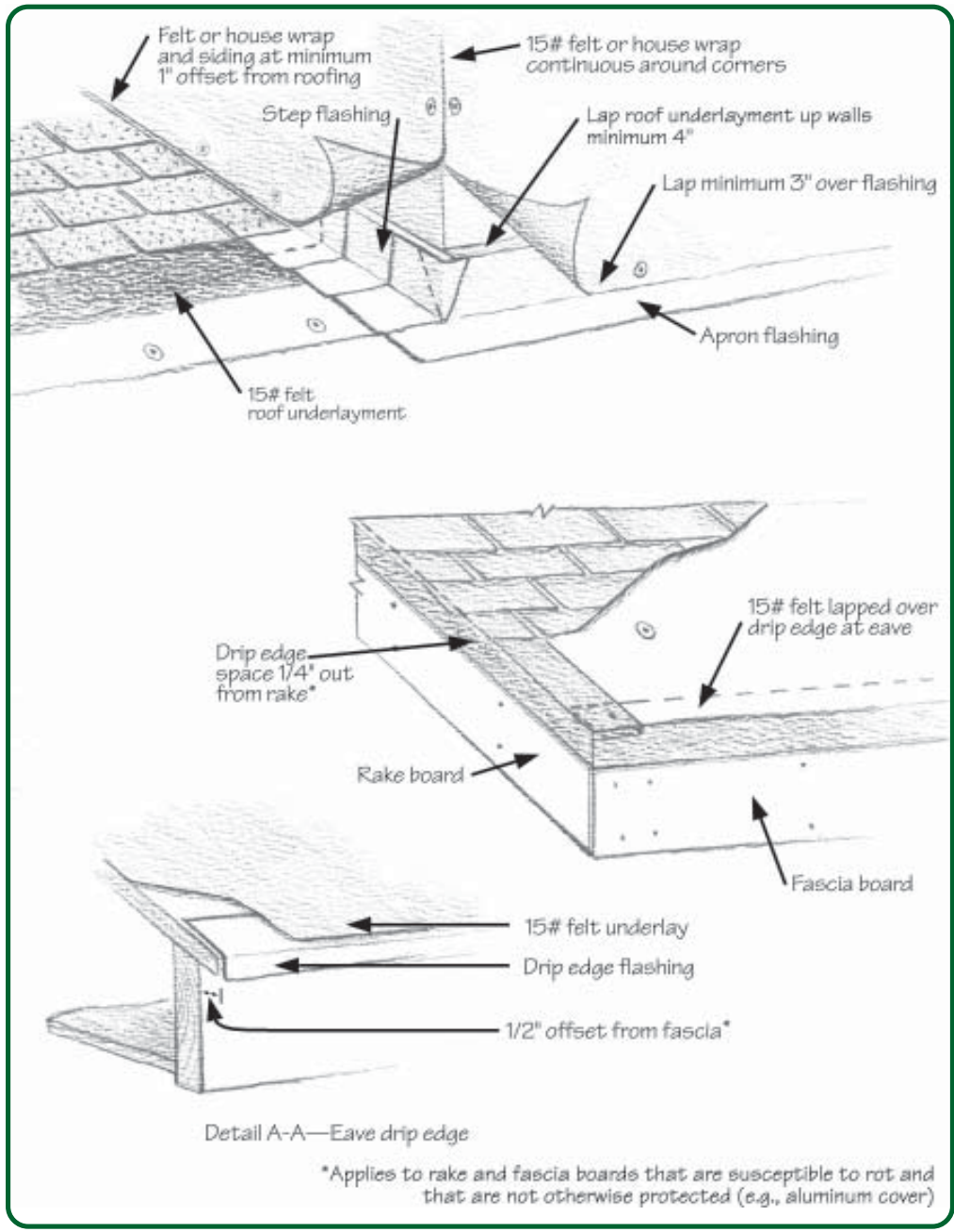

Figure 4.8a - Basic Roof Flashing Illustrations

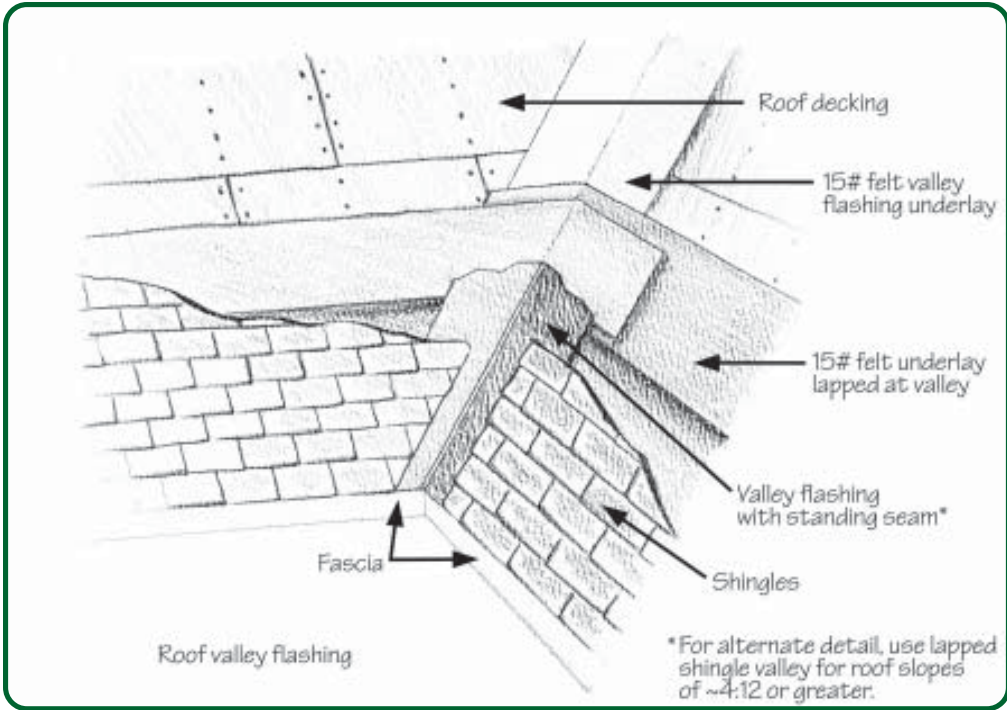

Figure 4.8b - Basic Roof Flashing Illustrations (continued)

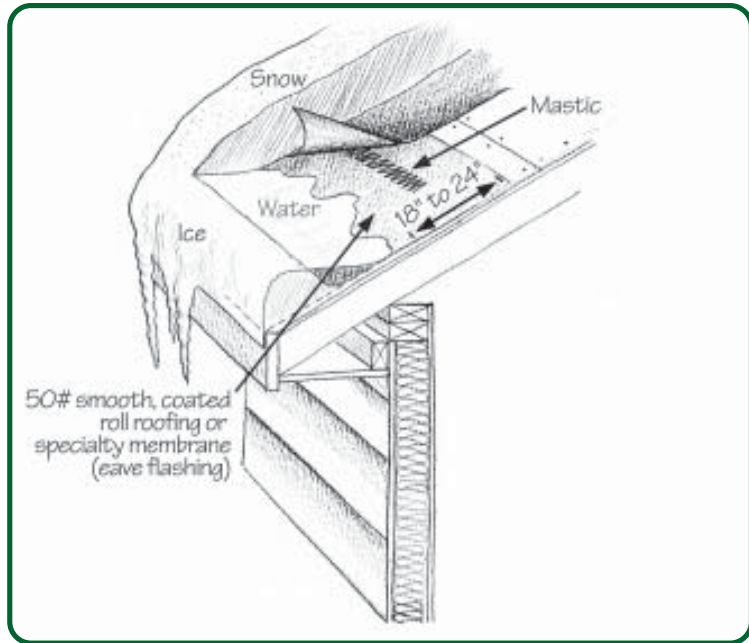

Figure 4.9 - Eave Flashing for Preventing Ice Dams

NOTES for Figure 4.9:

¹Extend eave flashing 18 to 24 inches inside the plane of the exterior wall.

²Overhang eave flashing 1/4 - inch beyond drip edge flashing.

³Apply mastic continuously to joints in eave flashing.

⁴If joints in the eave flashing are not avoidable, locate them over the soffit rather than the interior area of the building.

⁵While eave flashing is generally recommended for areas with an average January temperature less than 25°F, ice dams can be prevented by (1) adequate sealing of ceilings and tops of interior and exterior walls to prevent warm indoor air from leaking into the attic space, (2) adequate attic/roof insulation (usually local code requirements are sufficient) all the way out to the plane of the exterior walls and (3) proper ventilation through the eave and attic space.

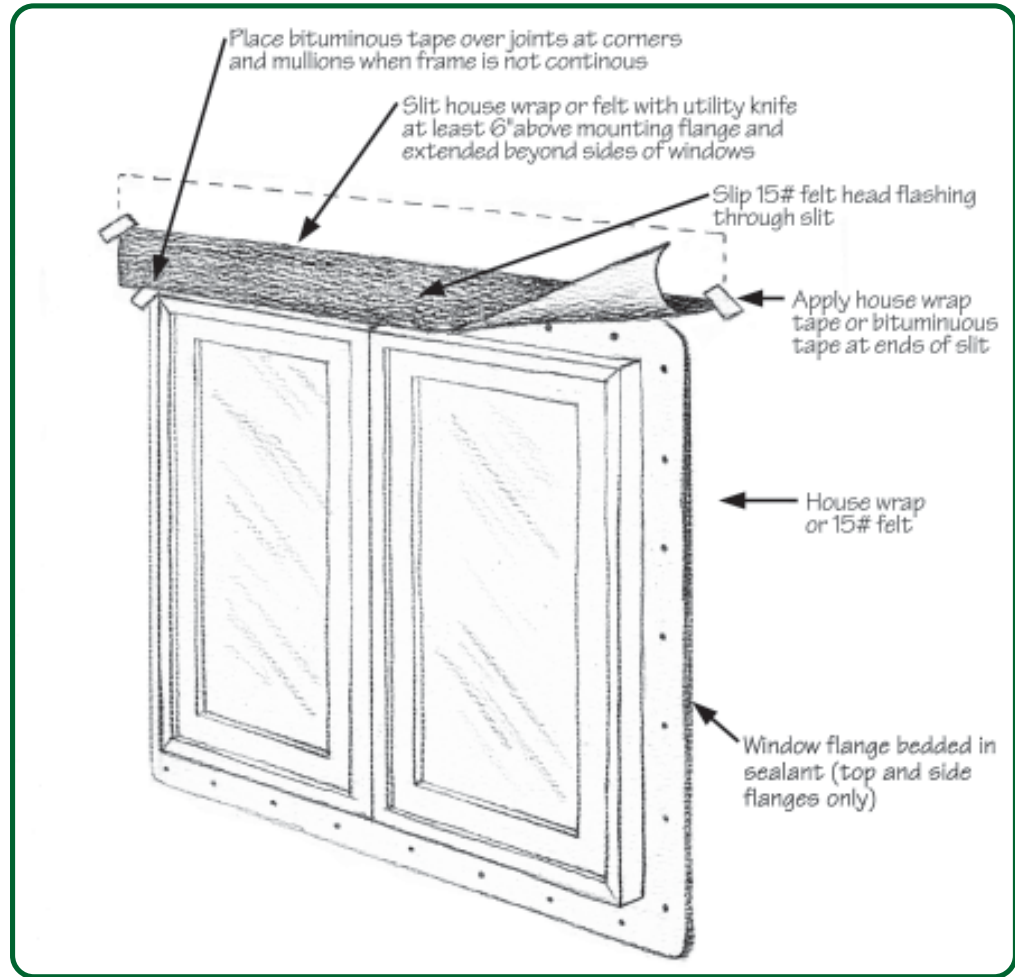

Figure 4.10 - Window Flashing Illustration
(building wrap installed prior to window; typical nail flange installation)

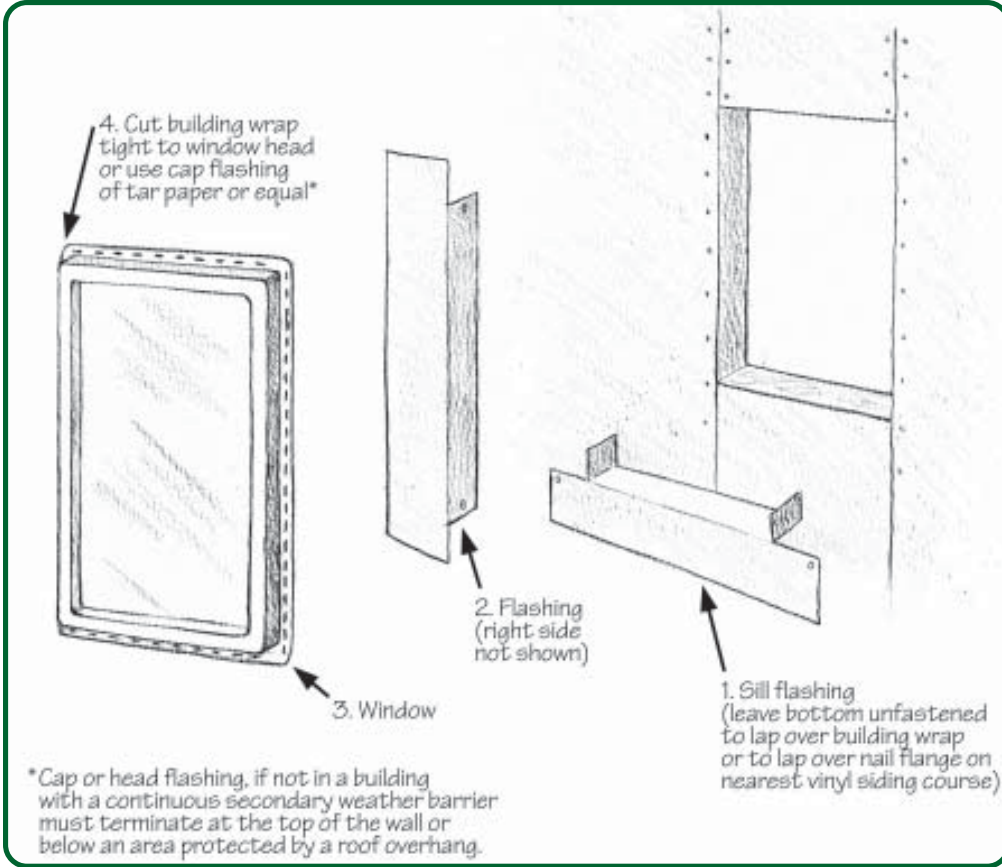

Figure 4.11 - Window Sill and Jamb Flashing Detail
(building wrap installed after window)

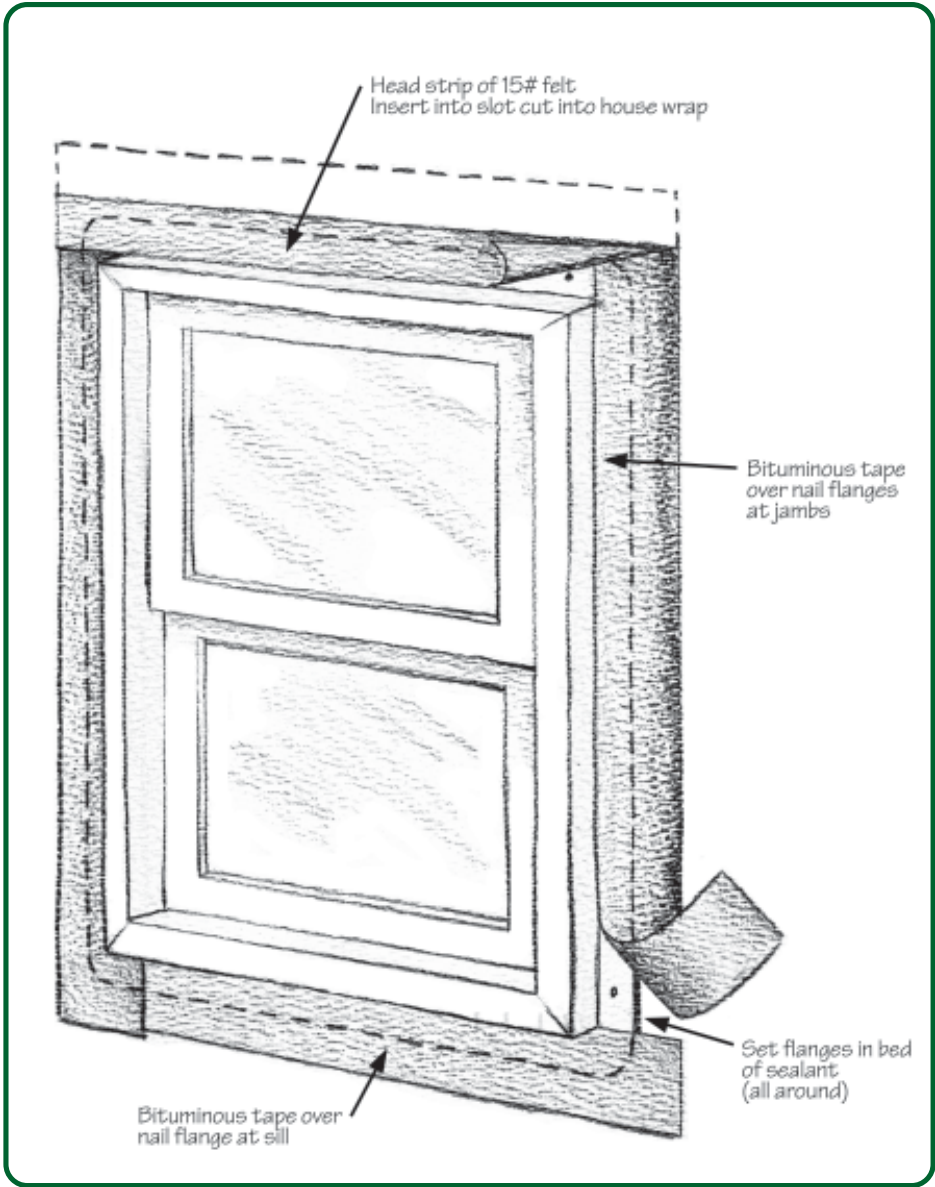

Figure 4.12 - Window Flashing for Severe Weather
(areas subject to frequent wind-driven rain)

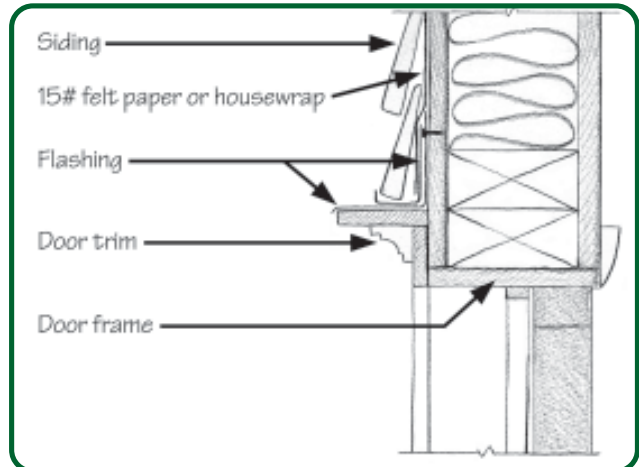

Figure 4.13 - Door and Head Trim Flashing Detail

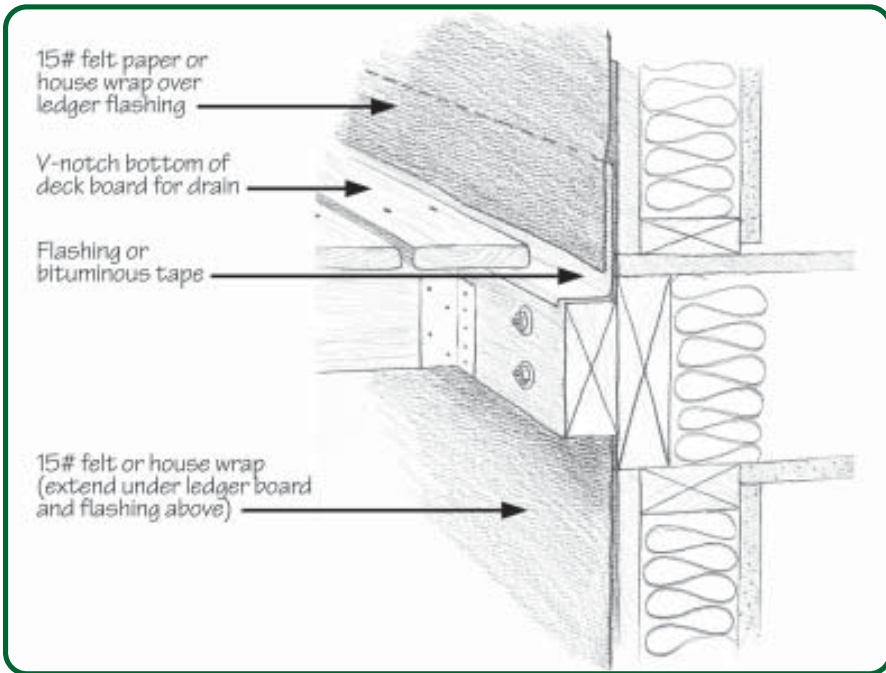

Figure 4.14 - Deck Ledger Flashing Detail

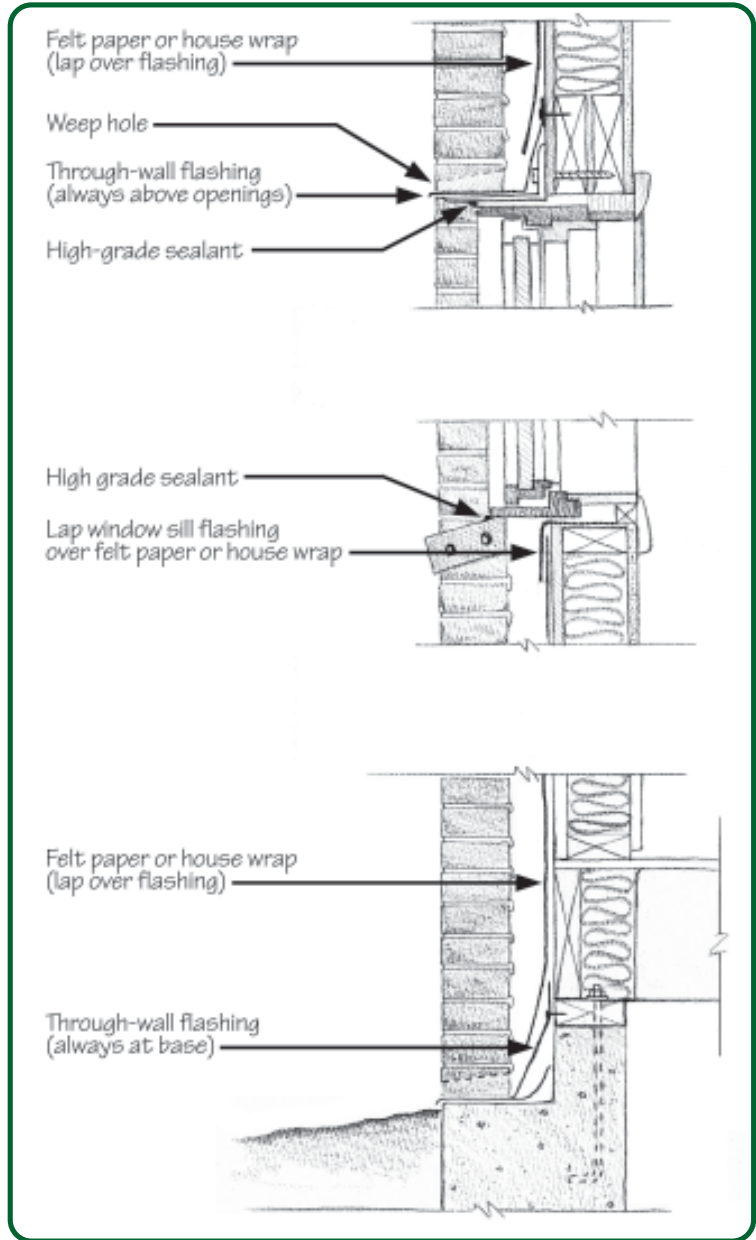

Figure 4.15 - Typical Brick Veneer Flashing Details

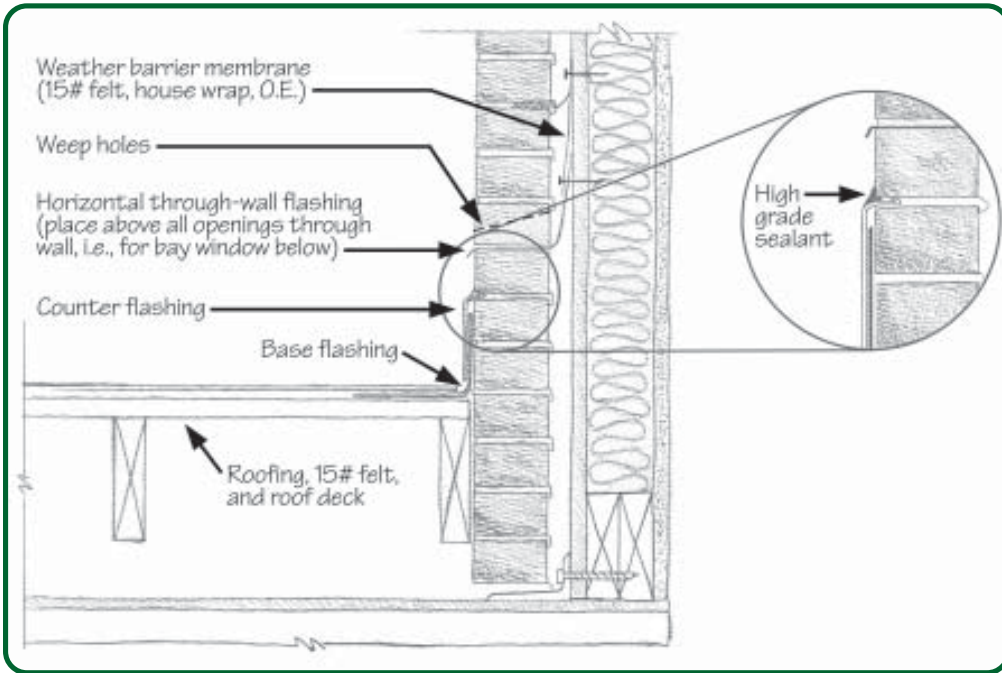

Figure 4.16 - Brick Veneer Flashing at Roof Intersections

4.2.5 Recommendation #5: Sealants and Caulking

In general, do not depend on sealants and caulking for long-term service. Using normal quality caulks and sealants with typical surface preparation, combined with shrinkage and swelling of building components, usually results in failure of a water tight seal within 2 to 3 years or less, particularly on southern exterior exposures. Nonetheless, there will be joints and seams that will benefit from appropriate use and maintenance of caulks and sealants. Optimally, joints in exterior wood trim or framing should be simple enough not to trap water and allow quick drying.

With reasonable adherence to manufacturer instructions (particularly with respect to surface preparation and conditions during installation), high quality caulks and sealants can be made to endure for a reasonable time (i.e., up to 5 years or considerably more when not severely exposed). Some recommendations regarding selection of quality caulks and sealants are provided in Table 4.7. In addition, caulks and sealants should be stored in a warm environment and should not be stored for more than a couple of years before use. Finally, the need for homeowner maintenance and replacement of caulking must be strongly emphasized.

4.2.6 Recommendation #6: Roof and Crawl Spaces - To Ventilate or Not to Ventilate

The use of ventilation has been a topic of confusion for some time. Until recently there has been little convincing research to confirm traditional practices or to suggest better ones. To aid in decisions regarding roof and crawlspace ventilation, recommendations are provided in Table 4.8 based on the best information available on the topic. Prior to use, the reader should consult local building code requirements and roofing manufacturer warranties to identify potential conflicts.

Roofs vents (when required) must be installed in accordance with the local building code or accepted practice. Plastic vent louvers commonly used on gable ends must contain UV inhibitors. Vents must be adequately screened to prevent vermin or insect entry. In addition, ridge vents (if used) should be installed and attached to the roof in accordance with manufacturer recommendations – numerous incidents of improper installation have resulted in damage during wind events or rain/snow entry to the roof. Vent area ratios, such as 1 square foot of vent

opening for every 300 square feet of attic area refer to the *net* vent area, not gross area; so the sizing of vents must account for obstructions to vents from louvers and screens.

The roof ventilation recommendations in Table 4.8 are based primarily on durability concerns. These recommendations are further based on the assumption that the following good practices have been employed:

- All bath and kitchen exhaust fans exhaust moist indoor air directly to outdoors.
- Indoor relative humidity is kept within reasonable limits (i.e., 40-60%) and significant point sources of moisture (e.g. hot tubs) are controlled with ventilation.
- Ceiling vapor barriers are used in accordance with Table 4.6.
- Proper attic insulation levels are installed for the given climate and location.

While non-vented roof assemblies are a viable alternative (especially in hot/humid climates), performance data on such designs over time is still lacking. Further, the required detailing that goes along with such a design (e.g., insulation detailing, controlling surface temperatures in the assembly to prevent condensation) may be less forgiving than a traditional ventilation approach in terms of durability. If a non-vented design *is* employed, some critical items to consider include:

- Local building department approval;
- Implications for roofing material warranty;
- All major air leakage points between the living space and the attic (wire penetrations, recessed light cans, plumbing lines, HVAC boots and chases, attic hatches) have been sealed to limit air leakage; and
- Perimeter wall insulation detailing to satisfy local fire and insect design requirements.

TABLE 4.7-CAULK CHARACTERISTICS AND APPLICATION RECOMMENDATIONS¹

Caulk	Life (yrs)	Best Uses	Adhesion	Shrink-free	Primer Use ²	Joint Type	Tack-free (hrs)	Cure (days)	Clean up with ³	Paint	Available Colors
Oil-base	1-7	not desirable	fair-good	poor	porous surfaces	non-moving to 1/4" w, 3/4" d	2-24	to 365	paint thinner	must	white, natural, gray
Acrylic-latex	2-10	indoors, protected, or painted	excellent, except metal	fair	porous surfaces for best results	non-moving to 1/4" w	1/4-1/2	3	water	best	white, black, gray, bronze
Butyl rubber	7-10	narrow openings in wood, metal, glass, masonry	very good	fair	none needed	non-moving up to 1/4"x1/4"	1/2-1 1/2	7	paint thinner, naphtha	best	white, clear, gray, black, brown, redwood, beige, bronze, sandstone
Polysulfide rubber	20+	anywhere	excellent	excellent	special primer on all but metal	all up to 1/2"x1/2"	24-72	7	TCE, toluene, MEK	if desired	white, black, gray limestone, bronze,
Silicone rubber	20+	outdoor metal, heat ducts, shallow joints	good, excellent with primer	excellent	porous surfaces	all from 1/4" d	2-5	2-5	paint thinner, naphtha, toluol, xylol	read label	brown white, black, clear, gray
Urethane	20+	anywhere	excellent	excellent	none needed	all to 1/4"x1/2"	4-14	4-14	MEK, acetone, lacquer thinner	if desired	white, gray, black, limestone, bronze; special colors
Weatherstrip/ caulking cord	to 20	temporary draft sealing and hole plugging	none	excellent	none needed	non-moving	--	none	not sticky	no	clear, gray

Source: *Structures and Environment Handbook*, Eleventh Edition (Midwest Plan Service, 1983)

NOTES:

¹Based on advancement in caulk formulation and materials, this table may be in need of revision and may not include newer materials.

²"Porous" includes wood, wood products, concrete, and brick.

³MEK = methyl-ethyl-ketone, TCE = trichloroethylene.

For crawlspaces, a non-ventilated crawlspace design can be employed in all of the climate regions shown in Table 4.8. A non-ventilated crawlspace offers benefits in terms of both moisture control and energy performance. Ventilated crawlspaces, especially in humid and mixed regions, often introduce moist outdoor air into a cooler crawlspace environment. The result is condensation and the resulting problems like mold and degradation of building materials. In terms of energy, an unventilated crawlspace also provides an area for HVAC equipment and ducts that doesn't present the temperature swings (and energy penalties) found in ventilated crawlspaces.

There's more to it than just taking out the vents however. The following steps must also be followed when building a unventilated crawlspace:

- Careful attention to exterior grading (4% slope *minimum*);
- Air sealing between outdoors and the crawlspace area to prevent humid air from getting into the crawlspace;
- Insulating at the crawlspace perimeter walls—not the floor;
- 6 mil polyethylene groundcover in crawlspace with joints lapped; and
- Damp-proof foundation wall.

TABLE 4.8 - ROOF AND CRAWL SPACE VENTILATION RECOMMENDATIONS

<u>Climate</u> ³	<u>Attic</u> ^{1,5}	<u>Cathedral Roof</u> ⁴	<u>Crawl Space</u> ²
Hot/Humid	Yes	Yes	No
Mixed	Yes	Yes	Not Preferred
Cold	Yes	Yes	Optional
Arid (dry)	Yes	Yes	Optional

NOTES:
¹All roof ventilation recommendations are based on the ceiling being sealed at all major air leakage points (i.e., chases, electric and mechanical penetrations, etc.) and bath and kitchen vent ducts adequately routed to expel air out-of-doors. In some climates (see Table 4.6), a ceiling vapor retarder (i.e., vapor retarder paint, polyethylene sheet, or asphalt coated paper) is required in addition to adequate attic/roof insulation.
²All recommendations are based on properly graded sites and the use of a continuous ground vapor retarder applied to the foundation area.
³Climates are defined as in Table 4.4.
⁴Cathedral roof ventilation must be continuous along soffit/eave and ridge.
⁵Net attic vent area should be 1/300 of attic area and vents shall be continuous along soffit/eave and also located at the ridge and/or gable ends.

CHAPTER 5 - Sunlight

5.1 General

Sunlight is made up of visible light and non-visible radiation such as ultraviolet (UV) and infrared (IR). Depending on the color and surface characteristics of an object, various wavelengths of solar radiation may be absorbed, reflected, and emitted (i.e., “released”). The more light absorbed and the less heat capacity (i.e., thermal mass), the greater the object’s ability to be heated by sunlight. For example, a dark driveway becomes much hotter on a sunny day than a light colored concrete sidewalk. Thus, the sun produces two significant effects that attack materials and shorten their life-expectancy:

- (1) chemical reaction (i.e., breakdown) from ultraviolet radiation and heat
- (2) physical reaction (i.e., expansion and contraction) from daily temperature cycles caused by objects absorbing and emitting heat gained from sunlight.

The chemical and physical reactions caused by sunlight can cause colors to fade and materials to become brittle, warp, or crack. Deterioration can happen relatively quickly (a year or less) or over longer periods of time depending on the characteristics of a material and its chemical composition. In some cases, materials like plastics that are vulnerable to UV degradation can be made resistant by adding UV inhibitors to the chemical formulation.

A prime example is vinyl siding. As an alternative approach, materials can be protected from sunlight by matter of design (e.g., providing shading or using reflective coatings).

UV light from the sun is not all bad. For example, it is UV light that causes a chemical reaction on special paper that forms the blue lines on blue prints. However, most everyone has witnessed or experienced the painful effects of UV radiation on skin, which causes sunburn. Consider that the exterior of a house is like its skin. Therefore, the proper selection of materials determines to what degree the building exterior will be able to withstand the damaging effects of UV radiation. The amount of solar radiation also varies by geography (see Figure 5.1); the number of cloudless days affects the dose of UV radiation over the lifetime of a product.

The following section presents a few measures that can help to counter the effects of solar radiation on building materials and systems. For homes, some of the primary problems associated with solar radiation are color fading, premature asphalt roof shingle failure, and vinyl siding warping. Excessive exposure to sunlight will also cause caulk joints to fail quickly. In addition, when shining through windows, sunlight can cause interior colors to fade.

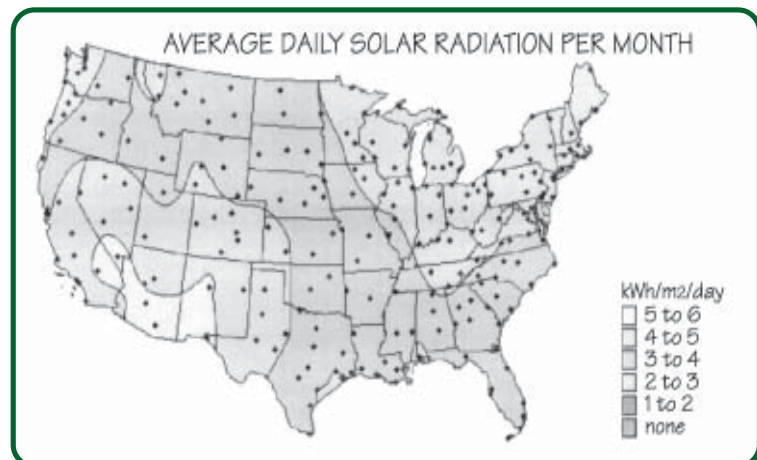

Figure 5.1 - Solar Radiation Map of the United States

Source: National Renewable Energy Laboratory

5.2 Recommended Practices

5.2.1 Recommendation #1: Overhangs

As with rain on the building envelope, properly sized roof overhangs can minimize the exposure to solar radiation and, hence, minimize radiation-related problems. The width of a roof overhang that will protect walls from excessive solar exposure in the summer while allowing heat gain through windows from winter sunshine depends on where the building is located with respect to the equator. The sun is higher overhead in the summer than in the winter. In addition, for any day of the year, at higher latitudes the sun is lower in the sky than at lower latitudes. Therefore, buildings situated farther south receive greater protection from the summer sun by roof overhangs, as shown in Figure 5.2.

The solar angle factors of Table 5.1 can be used to help determine overhang width to achieve the desired shading effect on south-facing surfaces. An example calculation shows how the solar angle factor is used.

TABLE 5.1 - SOLAR ANGLE FACTORS ¹				
Date	Latitude (degrees North)			
	24	32	40	48
To prevent winter shading:				
Dec 21	1.5	2.0	3.0	5.4
Jan 21 and Nov 21	1.2	1.7	2.4	3.8
Feb 21 and Oct 21	0.8	1.0	1.4	1.9
Mar 21 and Sept 21	0.4	0.6	0.8	1.1
To produce summer shading:				
April 21 and Aug 21	0.2	0.4	0.5	0.7
May 21 and July 21	0.1	0.2	0.4	0.5
June 21	0.0	0.1	0.3	0.5

Source: *Structures and Environment Handbook*, Eleventh Edition, Midwest Plan Service, Iowa State University, Ames, Iowa, 1983.

¹Factors apply for times between 9:00am and 3:00pm for winter shading and at noon for summer shading. Direct south facing orientation is assumed.

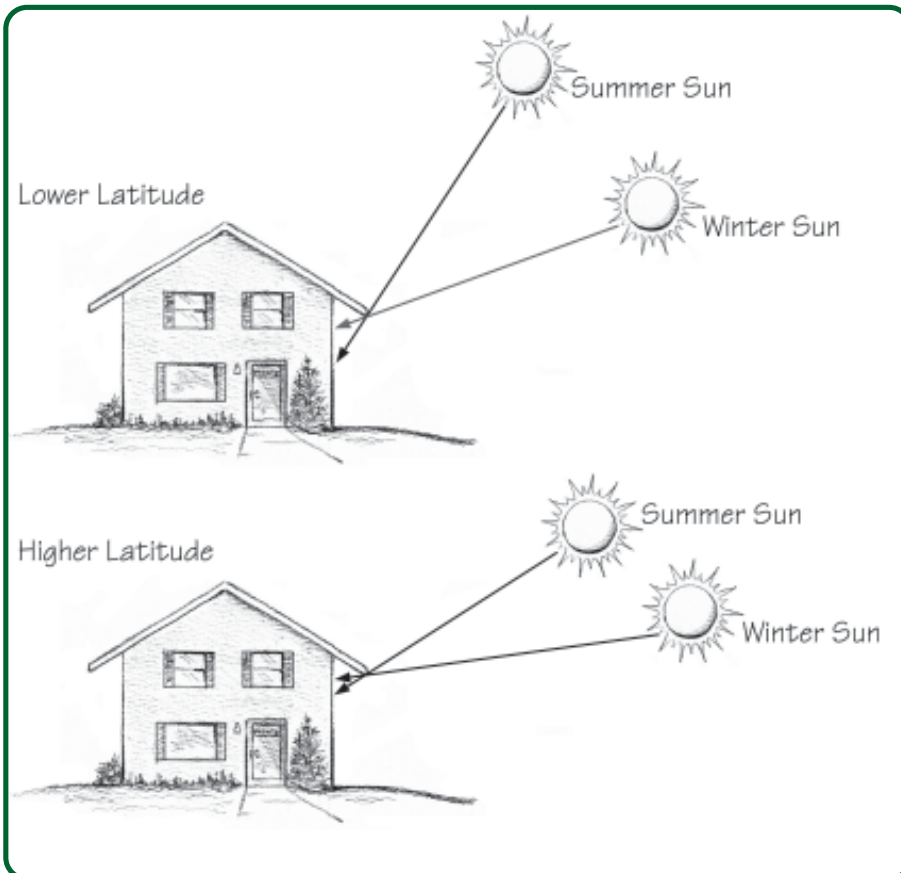

Figure 5.2 - Effect of Building Latitude on Effectiveness of Overhangs

EXAMPLE: DETERMINE ROOF OVERHANG WIDTH TO PROTECT WALL AGAINST SUMMER SUN

Find the overhang length (OL) to shade 6 feet of wall below the roof overhang for June through July. Building is located at latitude of 32 degrees North (consult Atlas for latitude). It is desired to provide shade for 6 feet of wall below the overhang at mid-day (i.e., to bottom edge of windows).

Solar Angle Factor (SAF) = 0.2 (for July 21) from Table 5.1

Wall distance below overhang to shade (WD) = 6 feet

$OL = SAF \times WD = (0.2)(6 \text{ feet}) = 1.2 \text{ feet}$

Use a 16-inch (1.33 feet) overhang which will provide roughly 6 feet 8 inches of shading below the overhang.

Determine degree of shading in the winter (using Feb 21) as follows:

$WD = OL/SAF = 1.33 \text{ feet} / 1.0 = 1.33 \text{ feet}$ or 16 inches.

The selected overhang width will provide no more than about 16 inches of shading to the wall during the main winter months of November through February. However, some shading to the top few inches of windows will occur in the early and late winter months when maximum solar heat gain may be desirable. But, in this case, the overhang width should not be decreased in the interest of maintaining weather protection of the wall.

5.2.2 Recommendation #2: Light Colored Exterior Finishes

As a second line of defense against damage from solar radiation, light colored materials and finishes can be selected. White is excellent and aluminum, reflective-type coatings are even better. Light colors can also reduce summertime cooling load and should reduce energy bills especially in cooling dominated climates by lowering the solar heat gain into a building. If properly accounted for in cooling load calculations, lighter colored roofing may allow for the use of smaller capacity air conditioning units. In addition, light colored roof shingles reduce shingle temperature and, therefore, increase shingle life. The effect of building exterior color on solar heat gain is illustrated in Figure 5.3. It is very important, however, to keep light colored finishes like roofs relatively clean to take full advantage of their reflectivity.

5.2.3 Recommendation #3: UV Protective Glazing

Windows that receive direct sunlight and that are not treated to block UV radiation will allow sunlight to enter and fade susceptible materials such as furniture coverings, carpeting, and drapes. One solution is to specify interior materials that have UV inhibitors or that are not susceptible to UV radiation. Another solution is to specify colors that will not show fading. However, if these options are not desired or considered sufficient, there are glazing options for windows and doors that block UV radiation. These relatively expensive treatments need only be specified for south-facing windows.

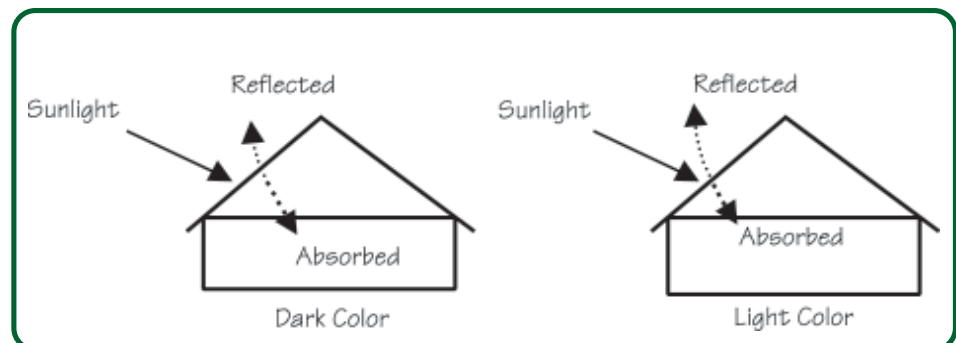

Figure 5.3 - Effect of Surface Coloration on Solar Heat Gain

5.2.4 Recommendation #4: UV Resistant Materials

Some materials are naturally UV-resistant, while others require the addition of UV inhibitors in the make-up of the material. For example, concrete or clay tile roofing and Portland Cement stucco or brick siding are naturally resistant to UV radiation and are also resistant to temperature effects compared to other exterior building materials. On the other hand, plastics are prone to “dry rot” (embrittlement from excessive UV exposure) unless UV inhibitors are provided. Plastics are also prone to significant expansion and contraction from temperature swings.

Be sure that UV inhibitors are used in materials that require protection. Many low budget components, such as some plastic gable end vents, may also lack UV resistance. All other factors being equal, choose the material with the best UV resistance if exposure to the sun is a concern.

5.2.4 Recommendation #5: Landscaping for Shading

Trees planted near a home along the southern exposure provide shading when most needed during the day (see Figure 5.4). Also, deciduous trees, such as maple or oak, should be used so that winter sun can reach the building. With appropriate planning, trees can also serve as a wind break to minimize the effects of wind-driven rain. Trees should be planted far enough away from a house to prevent possible damage from limbs or roots, as well as clogging gutters. Bear in mind that the greatest amount of solar radiation is generally received between 9 am and 3 pm. However, shading of only the late day sun (i.e., after 3 pm) is often a preferred and more practical solution for many sites.

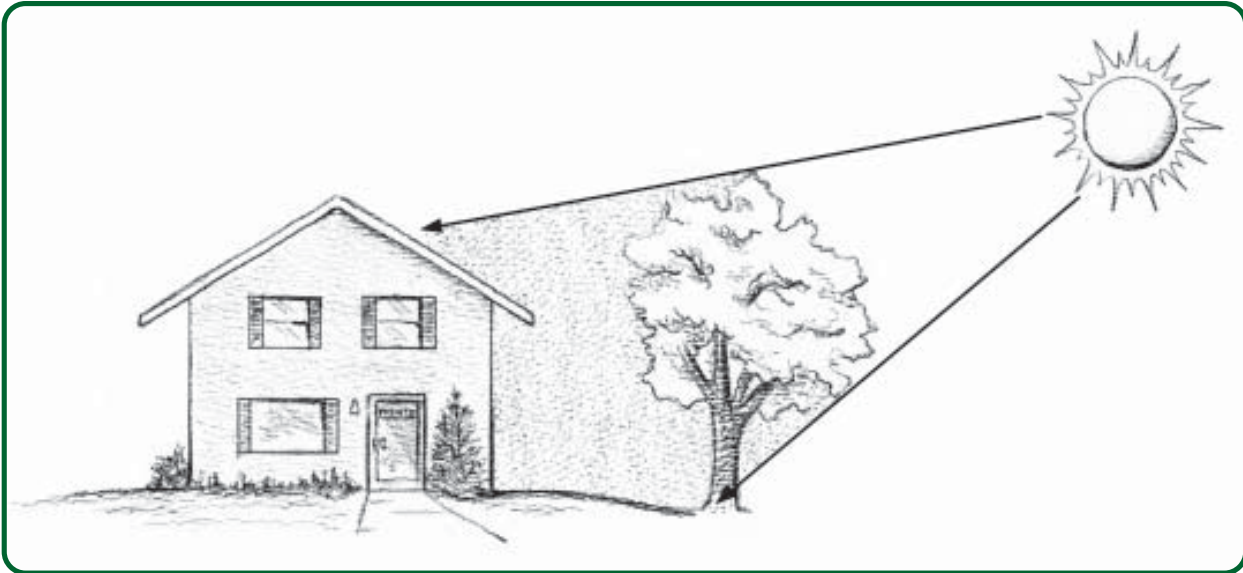

Figure 5.4 - Illustration of Solarshading

EXAMPLE: DETERMINE LOCATION OF SHADE TREE TO PROTECT AGAINST SUMMER SUN

Use the following equation and the solar angle factors (SAF) of Table 5.1 to determine the appropriate location of a maple tree (mature height of ~60') southward of a building wall (8' height) that is to be shaded during summer months. The building latitude is 40° North (refer to atlas for site latitude).

$$d = \text{SAF} \times h_o \left(h_o - h_s \right)$$

where:

- d = distance between object obstructing the sun at highest point and item to be shaded
- h_o = height of the object obstructing the sun
- h_s = height of object to be shaded
- SAF = solar angle factor (from Table 5.1)

The following values are given:

- SAF = 0.4 from Table 5.1 at 40°N latitude for May 21 or July 21
- h_o = 60 feet
- h_s = 8 feet

Substituting in the equation above,

$$d = (0.4)(60 \text{ ft} - 8 \text{ ft}) = 20.8 \text{ ft}$$

Therefore, the center of the maple tree should be located about 21 feet southward from the wall or windows to be shaded. Note that the shading at the first day of summer (June 21) will be slightly less due to the higher solar angle than assumed above. In addition, the tree should not overhang the building at its mature age. Thus, a distance smaller than about 20 feet is not recommended and the distance should be increased for trees that are larger at maturity.

CHAPTER 6 - Insects

6.1 General

Insects are not just nuisances, some are also a serious threat to building durability. The following types of insects are known to damage wooden materials in homes and in other structures:

- Termites,
- Carpenter Ants,
- Wood-boring Beetles, and
- Carpenter Bees.

While all of the above insects can pose a threat to wood-framed homes, termites are the most prevalent and damaging insect. Therefore, most of this chapter addresses issues and practices related to the control and prevention of termite infestation. Some of the practices for repelling termites, such as eliminating hidden areas that termites can travel through undetected, are also relevant to carpenter ants. Carpenter ants and wood-boring beetles, like termites, can be treated chemically with insecticides. Carpenter bees can be deterred by plugging entrance holes that commonly occur on wood siding and soffits.

There are about 56 species of termites in the United States that can be placed into two groups: subterranean (ground inhabiting) and non-subterranean (wood inhabiting). Subterranean termites are the most common and are responsible for most termite damage to wood structures. Therefore, this chapter focuses on subterranean termites. If non-subterranean termites are present, special measures may be necessary to eliminate them. Fortunately, non-subterranean termites live in much smaller colonies and are much slower acting than subterranean termites.

One variety of the subterranean termite group is the Formosan termite—an Asian termite introduced to the United States following WWII. The Formosan termite is different from the native subterranean termite in that it has a much greater colony size and thus damages wood at a much faster rate. Estimates state that a colony of Formosan termites will consume nearly 1,000 pounds of wood per year, whereas other termite varieties will only eat a few pounds annually. Formosan termites are also more likely to survive in a building with minimal ground contact, even though they require a constant source of water like other subterranean termites. Formosan

termites are expanding in range, and are currently found in the Gulf Coast states and southern states along the Atlantic coast.

A termite hazard or probability map, shown in Figure 6.1, is frequently used by building code authorities, designers, and builders to determine when certain termite prevention or control methods should be used. Some building codes may vary in delineation of the termite probability zones based on local conditions. The termite hazard map generally corresponds to the geographic limits of reported termite damage as shown in Figure 6.2. The inclusion and degree of termite control and prevention used in a building depends on the risk of termite infestation as defined in Figures 6.1 and 6.2, as well as local experience.

In summary, termites like to eat wood and they don't care if it's in your home. In areas subject to termite infestation, at least one of the practices listed in Section 6.2 should be used.

6.2 Recommended Practices

There are basically three techniques for controlling or preventing termite damage:

- Chemical soil treatment or baits,
- Termite shields, and
- Use of termite resistant building materials.

6.2.1 Recommendation #1: Chemical Treatment

Types

Chemical treatments for termite control come in a variety of forms. Generally, chemical treatments for termites include soil termiticides, termite baits, and treated wood products. This section will only discuss soil and bait termiticides.

Chemical soil treatments are designed to form a protective barrier around a structure to prevent termites from contacting or penetrating the building.

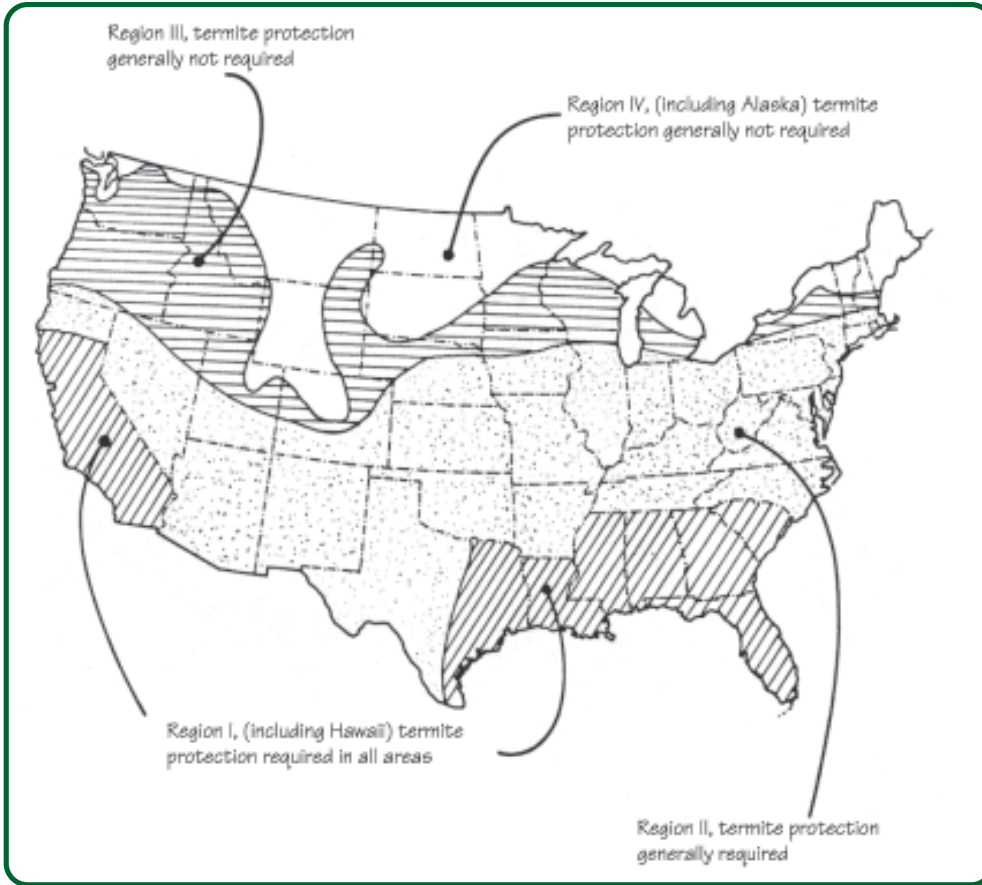

Figure 6.1 - Termite Probability (Hazard) Map



Figure 6.2 - Extent of Recorded Termite Damage

Source: Wood Handbook, USDA - Forest Products Laboratory, Madison, WI, 2000.

Soil treatments are the most common form of termite control used by the building community. Commercially, there exist about a dozen soil treatments that, by various biological means, kill termites or repel them. Termiticides are generally preferred over repellents.

Termite baits are encapsulated termiticides designed to lure insects to the bait, be eaten, and then killed. The poisons are designed to act slowly so as to not repel the insect and to facilitate the consumption and transport of the poison to the nest. Other termites ingest the termiticide from the insects that feed directly on the baits through secretions emitted by the original feeders.

Application

Chemical soil treatments are generally applied to the soil around the foundation of a home to act as a shield against termites. The treatments are performed prior to pouring the slab or foundation, shortly after foundations and slabs are poured, and at periodic intervals for the life of the structure. Directions vary according to the chemical used, but these locations are of special concern for chemical application:

- Soil along foundations and crawl spaces;
- Areas of soil disturbance such as bath traps;
- Soil under appurtenances such as attached slabs and porches;
- Soil in inaccessible or concealed spaces; and
- Soil in proximity to slab or foundation penetrations due to plumbing, wiring, etc.

Termiticides are applied by one or more of the following methods: trenching around a foundation and flooding the trench with a sprayer; inserting a rod at periodic intervals around a foundation and injecting the chemical in the soil; and drilling holes in masonry slab or foundations and injecting the chemicals into the soil through the holes. Factors such as access to targeted areas, presence of landscaping, and the chemical employed dictate the treatment option used by the pesticide applicator. A certified pest control operator (PCO) is required for application of most termiticides.

Performance of termiticides varies considerably with climate, soil type, structure design, and homeowner practice. Locations with frequent precipitation, impermeable or very permeable soils, or great soil disruption from landscaping activities will require frequent re-application in order to maintain termite-resistive properties.

Termite baits are applied to the ground at intervals around the home as prescribed by the product label. Some bait systems employ only a

cellulose bait that requires frequent monitoring. Once termite activity is detected, a poison is inserted into the bait housing. Other bait systems contain both termite lure and poison in one formulation. The key to satisfactory performance in a bait system is proper monitoring and placement. Do-it-yourself termite bait kits are available to the general public, but the temptation is to purchase too few and monitor the baits infrequently, thus severely hampering their effectiveness. Many pest control operators offer bait systems which better assure proper bait placement and monitoring.

Re-application and Inspection Services

Chemical termiticides have a limited life because of leaching or chemical degradation. In addition, homeowner activities such as disruptive landscaping tend to limit the effectiveness of chemical treatments. Therefore, many homeowners opt to employ a termite service offered by pest control operations.

Typically, a contract with a PCO involves an initial treatment of the structure with a chemical termiticide or bait system, followed by an annual inspection of the structure with periodic retreatment performed when required. Many PCO's offer warranties that provide free retreatment if infestation is detected. Few offer warranties that pay for repair or replacement of termite-infested materials.

The benefits of an inspection and treatment service include periodic inspection of a home by knowledgeable technicians and quick remedial action when infestation is detected. A client can be better assured of a competent applicator if the PCO is a member of the National Pest Management Association (NPMA). NPMA promulgates the standards that constitute proper treatment of buildings.

6.2.2 Recommendation #2: Termite Shield

A termite shield is placed between a masonry foundation and wood framing to prevent termites from gaining access to the wood framing components. Termite shields (Figure 6.3) must be of termite-resistant materials such as metal or concrete. Some termites are able to chew through plastics and thin metals. Also, any seams in a termite shield must be soldered or otherwise sealed. Since termite shields require a high degree of care in installation, they are best used in combination with soil treatment. They should always be used when there are potential hidden pathways. Construction types known to create hidden pathways for termites

include slab-on-grade (except monolithic slabs of good construction), masonry construction, and brick veneer construction.

Hidden pathways allow termites access to wood materials through pathways that cannot be detected during periodic inspection. When there are no hidden pathways in construction, subterranean termites can be easily detected by the presence of shelter tubes—tunnels that are made of mud to protect them from light and keep them moist. Because termite shields are difficult to install on slab-on-grade construction or split-level construction, other methods of termite protection (e.g., soil treatment) are generally preferred for these types of foundations. It is also noteworthy that termites can gain hidden access through cracks as small as 1/32-inch wide. Therefore, if concrete is used as a barrier to termites, it should include welded wire fabric or sufficient reinforcement to control cracking. Examples of concrete as a termite barrier are illustrated in Figure 6.4.

6.2.3 Recommendation #3: Termite-Resistant Building Materials

Wood can be protected against termite damage by use of preservative treated wood (e.g., CCA or Borate). Using treated lumber to frame a home can add as much as \$3,000 to the price of a typical home. Such a drastic measure, however, is only used in particularly severe termite hazard areas like Hawaii.

As an alternative, preservative-treated wood may be used in isolated locations such as foundation sills and floor framing directly above the foundation. This practice is particularly appropriate for crawl space construction and for basement construction when ceilings are finished such that these elements are not easily inspected for infestation. Alternatively, naturally decay-resistant wood (e.g., heartwood of redwood and eastern red cedar) may be used, but at even greater expense than preservative treated lumber. For this reason, materials such as galvanized cold-formed steel may be a cost-effective alternative and are frequently used in Hawaii to complement or compete with the use of preservative treated wood. Concrete and masonry building materials are favored alternatives in areas such as Florida.

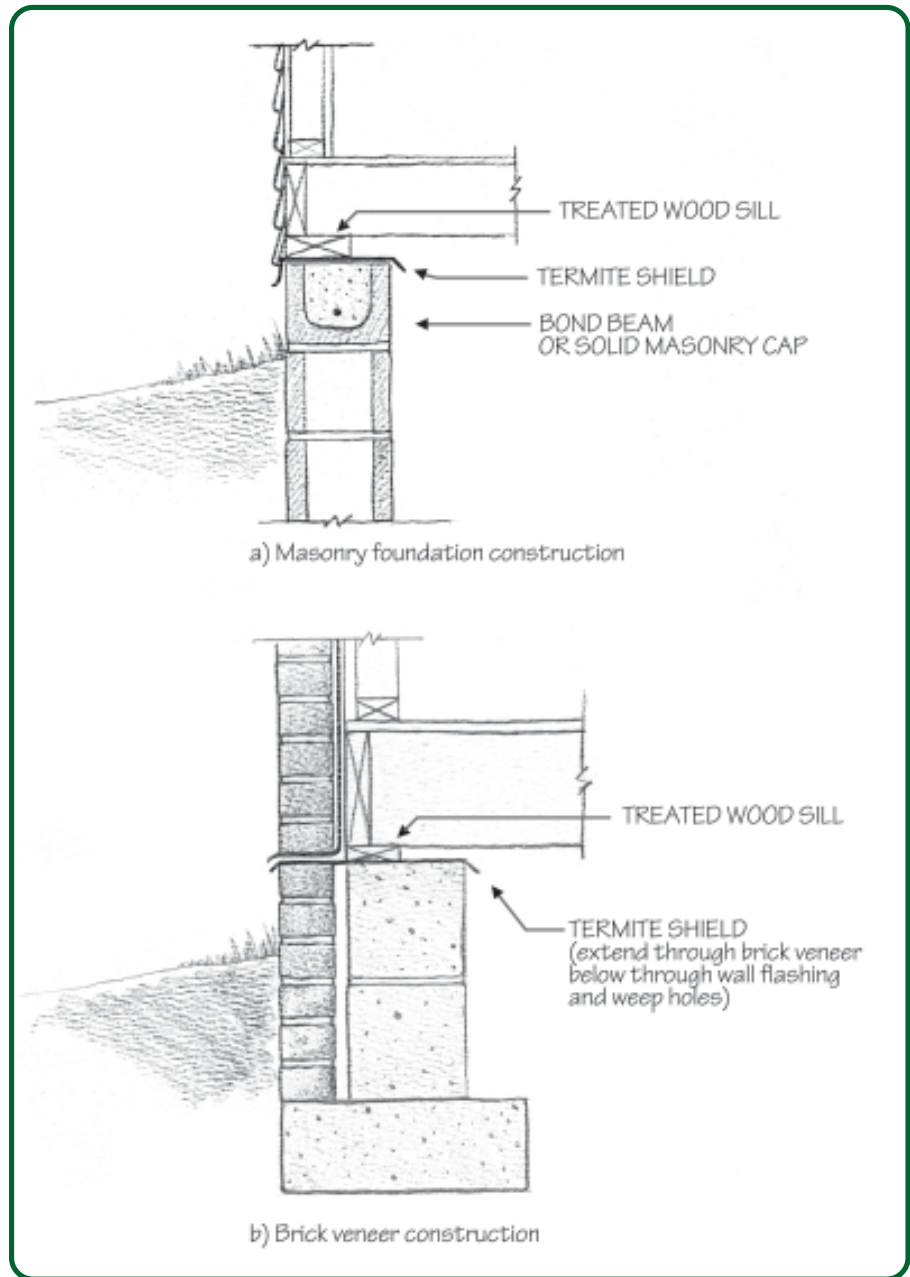

Figure 6.3 - Use of Termite Shields

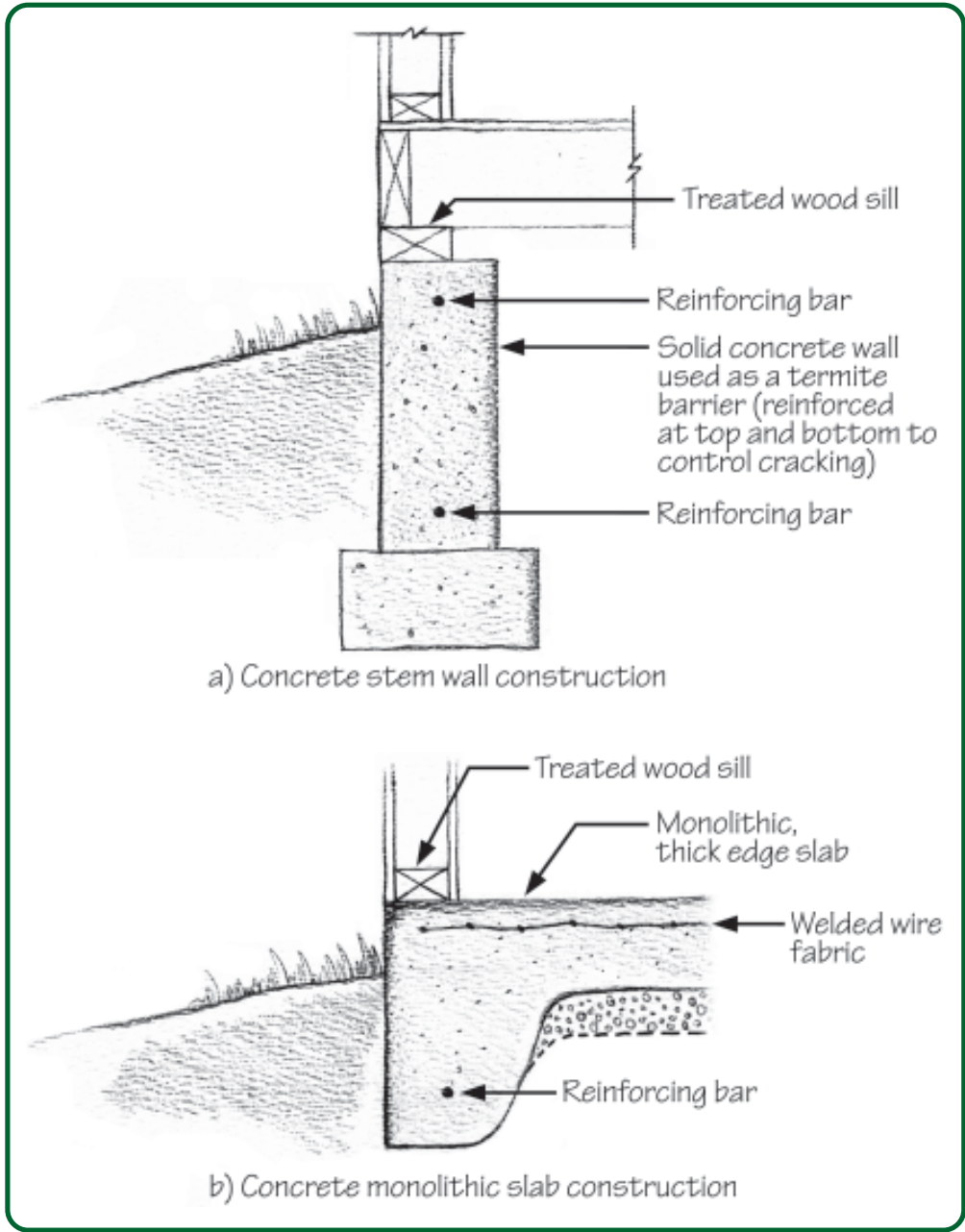

Figure 6.4 - Use of Concrete as a Termite Barrier

CHAPTER 7 - Protection Against Decay and Corrosion

7.1 General

At a moisture content of greater than 25 percent, wood is subject to fungal attack or decay. Decay will be rapid when the temperature is in the range of 70 to 85°F. The potential for wood decay when exposed to the outdoors, therefore, varies in accordance with climate (refer to Decay Hazard Map, Chapter 4, Figure 4.3). However, wood exposed to excessive moisture within any building wall in any climate, particularly one with a low drying potential (refer to Chapter 4), will grow mold and rot.

As it is for termites, wood is a food source for certain molds when conditions are right. Therefore, it is generally recommended that untreated wood be maintained in conditions where the moisture content does not exceed 20 percent.

There are essentially three options for preventing wood decay:

- Protect (or separate) wood from moisture;
- Use naturally decay-resistant wood; or
- Use preservative treated wood.

Of equal concern to the exterior use of wood material is the corrosion resistance of fasteners that must hold wood joints firmly together. Finally, it is important to consider cost-effective alternatives to wood that offer potential durability and maintenance benefits. In combination with measures presented earlier in this guide, particularly Chapter 4, recommendations in the following section should address all of the major concerns regarding durability of wood construction.

Naturally decay-resistant wood species include black locust (often used as fence posts) and heartwood of baldcypress, redwood, and cedar. Due to cost and scarcity of these wood materials, however, preservative treated wood is generally the favored choice unless aesthetics demand otherwise. Of

course, alternatives to wood such as concrete, masonry, or steel construction may also be considered.

7.2 Recommended Practices

7.2.1 Recommendation #1: Separation from Ground

One of the oldest and most trustworthy practices to prevent wood decay is separation from constant uptake of moisture from the ground. In most normal outdoor exposures, wood will come to an equilibrium moisture content of less than 20 percent, although short periods of greater moisture content can occur. When enclosed in building construction, the moisture content of wood will typically reach equilibrium with the surrounding environment at a moisture content of 8 to 12 percent. However, in constantly damp locations or in conditions of extremely high humidity, the moisture content will increase up to the saturation moisture content of wood (approximately 30 percent). In most cases, this condition is related to the lack of adequate separation from ground moisture. Damp conditions can occur when wood is in direct contact with the ground or when wicking through other materials such as concrete or masonry occurs. Some well-known, code-required details for separation of wood from ground moisture are shown in Figure 7.1. If this separation is not possible, and as a reasonable precaution in all cases, wood sills and other members in direct contact with the ground or concrete/masonry near the ground level should be preservative treated.

7.2.2 Recommendation #2: Exterior Wood Protective Finishes

Another method for protecting wood from moisture is to apply a protective wood finish. The options for exterior wood finishes are wide ranging and include the following options:

- Natural weathering
- Water repellents
- Water repellent preservatives (pigmented and non-pigmented)
- Pigmented penetrating stains (semi-transparent)
- Solid color stains
- Paints

Outside of aesthetic preferences, the choice of the best finish and its effectiveness will depend on the type of wood, its surface condition, and the climate, among other factors. For example, the smoother a wood surface, the less effectively a finish will adhere or penetrate. Boards with a vertical or edge grain (i.e., cut radially across the growth rings of a log) result in much more durable finishes than the more common flat grain (i.e., cut tangentially to the growth rings) for reason of differences in tendency to shrink, swell, and cup (warp). Edge grain lumber also weathers better than flat grain. The more dense a wood is, the less effectively a finish will adhere or penetrate. Hardwoods often require special preparation due to pores in the wood. Finish

life is decreased because of high shrink-swell potential in moist environments. However, in protected environments (such as interior flooring) hardwood floors are known for their beauty and durability. In all cases, the moisture content of the wood must be sufficiently low (i.e., less than 20 percent) to allow for proper application of a durable and effective exterior finish. Wood composites (including veneers such as T1-11) that have the potential to swell require special protection from moisture and should not weather naturally.

Exterior wood finishes require vigilant, periodic maintenance. However, in normal climate conditions, a good exterior wood paint finish should last up to 10 years and stains for as long as 5 years before diminished function or appearance. Water repellents and water repellent preservatives generally require more frequent retreatment, but the treatment effectiveness and longevity improves as the wood weathers and becomes able to absorb more of the treatment. Penetrating stains also experience this effect and will increase in effectiveness during the second and subsequent treatments, with service life extending to as much as 10 years between treatments.

The most important factors to consider are:

- Choosing the most appropriate and cost-effective wood material;

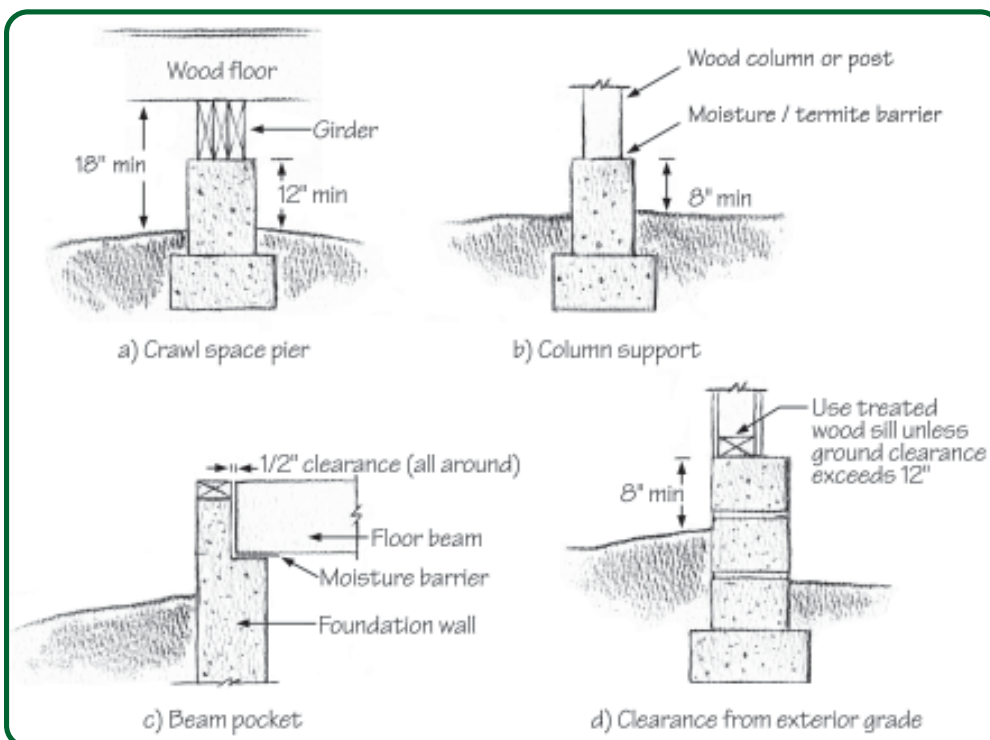

Figure 7.1 - Details to Separate Wood from Ground Moisture

- Matching the selected wood material with a compatible finish;
- Applying the finish properly; and
- Educating the owner on the need for periodic maintenance.

All of these factors will not be very effective without proper moisture control, particularly for natural (untreated) wood siding and trim materials. Refer to Chapter 4 for guidance on measures for moisture control with specific interest in the use of weather barrier construction, vapor retarders, flashing, and overhangs. Overhangs are important in that they modify the exposure that siding and trim materials will experience, and enhance the service life of the finish.

The types of performance problems that may be experienced with finishes when the above factors are not appropriately addressed include:

- Moisture penetration
- Mildew
- Wood pigment staining (“bleed through”)
- Peeling
- Blistering
- Checking
- Cracking and “alligatoring”
- Excessive chalking

There are numerous types of paints, stains, and preservatives with varying cost and performance. It is beyond the scope of this guide, however, to go into great detail about the various products. Neither does this guide address special considerations regarding the repainting of wood or painting of other materials, such as galvanized or plain steel. Refer to the following references for a more detailed treatment of exterior and interior wood finishing:

- *Finishes for Exterior Wood* (Forest Products Laboratory, USDA, 1996); and
- *Builders’ Guide to Paints and Coatings* (NAHB Research Center, 1993).

The recommendations given in Table 7.1 are intended to give the best exterior finish results for typical conditions and a wide variety of wood materials commonly encountered in home construction and exterior finishing applications.

Judging Paint Quality

The quality of paint is generally determined by the following factors and is usually correlated to price:

- High solids content,
- Low ratio of pigment to vehicle, and
- Type of binder or vehicle.

Unfortunately not all paint labels include the above information. Therefore, consult a paint

specialist or the manufacturer for additional information; otherwise, it is generally safe to assume that cost is directly related to quality. When considering price, it is important to realize that paints with less solids content may result in the need for more coats to provide adequate coverage. Therefore, it is usually cost-effective to invest in high quality paints.

In general, low gloss or flat paints (high pigment to vehicle ratio) use more pigment content and are less durable than gloss paints; and latex acrylic paints are more flexible and resilient than oil-based (alkyd) paints. Regardless of the paint selected, application instructions provided by the manufacturer should be carefully followed for best results.

Many people falsely believe that painting wood will stop decay. In fact, painting wood that has already begun to decay can trap moisture and promote decay. Paint is primarily used as an aesthetic finish that also serves to protect wood from intermittent wetting (as from rain) and weathering from sunlight (UV radiation). A good quality (moisture resistant) paint will help to moderate the moisture swings through which exterior wood would otherwise be exposed. If frequent wetting occurs to painted wood, it may even be more likely to decay than unpainted wood if not properly maintained, particularly at end joints of lumber trim, siding, and window and door casings.

Wood absorbs moisture nearly 30 times more rapidly through the end grain than through its sides. If moisture is absorbed, painted wood will tend to dry slower than unpainted wood and accelerated rotting can occur near end joints. Therefore, it is always a good practice to keep joint designs simple and to pre-treat all end joints with a water repellent preservative prior to installation and finishing.

TABLE 7.1 - RECOMMENDED FINISHES FOR EXTERIOR WOOD

Wood Material	Applications	Finish Recommendations (Preferred option is bold) ¹	Special Enhancements
Untreated (natural) wood	Siding, Trim, Railings, and other items not in ground contact	Paint: Prime all sides with acrylic latex “stain blocking” primer Apply two coats of all-acrylic latex house paint ⁴ Opaque stain (latex) ⁵ : Use same procedure for paint (best for rough surfaces).	(a) Treat end joints with a “paintable” water repellent preservative; allow 2-3 days to dry prior to painting; (b) Top coats and primer should include mildew-cide
Treated wood ²	Decks, Columns, Framing, Fascia Boards, Trim	Paint: Same as above Opaque stain (latex) ⁵ : Use same procedure for paint; do not use on decking (best for rough surfaces) Semi-transparent stain: Best for wood decks and general use on treated wood; apply two coats	(a) Treated wood is usually high in moisture; let dry for several weeks prior to application of finish (b) Best if wood is slightly weathered for penetrating stain
Naturally decay-resistant wood	Siding, Trim, Decking, Columns, Framing, etc.	Semi-transparent stain: Same as above for treated wood (use decay-resistant wood) Water-repellent preservative: Apply two coats; use pigmented version if natural wood color is not desired or use semi-transparent stain for deeper color modification Water repellent: Apply two coats	Painting as for non-decay-resistant wood is also applicable; special care should be taken to make sure stain blocking primer is used.
Wood Composites ³	Siding, Trim	Paint: Same as above for untreated (natural) wood. Opaque (solid color) stains ⁵ : Same as above for paint; works best on rough surfaces such as T1-11 siding	(a) Treatment of end joints/cuts particularly important to prevent edge swelling (b) Penetrating stains and other “natural” finishes should not be used (c) Use of overhangs as additional protection should be considered depending on climate

General Application Recommendations:

- All surfaces should be clean and dry.
- For painted surfaces (including opaque stains) that are very smooth, the surface should be lightly wetted and allowed to dry for several days, then sanded with #50 to #80 grit sand paper.
- Do not apply paint when temperatures are or will soon drop below 50°F or when heavy dew is suspected prior to complete curing. Avoid painting surfaces that will soon become heated by the sun (i.e., follow the sun around the building).
- Closely follow manufacturer application instructions and coverage recommendations. Coverage is generally around 400 ft² per gallon for paint and opaque stains and 200 ft² per gallon for penetrating stain. Rougher surfaces will reduce coverage amount per gallon.
- Multiple coats: For penetrating stains, time between coats should allow for drying; for water repellent preservatives, time between coats should not allow drying; for paints, time between coats should allow 2 days for curing, but not more than 2 weeks.
- Brushed on finishes (especially using back brushing technique) will generally improve finish coverage, penetration, and/or adherence to the wood surface.
- Use corrosion resistant fasteners; deformed shank nails should be considered for siding and trim attachment; stainless steel nails should be considered for natural wood finishes. Use hot-dipped galvanized nails for treated wood.
- Use of furring behind siding to create an air gap will increase finish and wood siding service life.

NOTES:

¹Based on a subjective consideration of general aesthetics and, primarily, durability relative to other choices.

²Treated wood refers to wood treated with water-borne preservative such as Copper Chromium Arsenate (CCA). CCA is paintable and stainable and the wood treatment can actually enhance finish performance provided the wood is dry and the surface is not very smooth or weathered. Weathering, however, does enhance the application of penetrating stain.

³Wood composites include OSB, plywood (i.e., T1-11 textured siding panels), and fiber board or hardboard. Follow manufacturer application, installation, and finishing instructions carefully when using these materials.

⁴Paint top coats are generally applied after installation, although the first top coat may be applied prior to installation on all sides, but more importantly the end grain and exposed sides. Second top coat may be omitted if coverage is sufficient and when used only on sides of the building not facing south or west; however, this may shorten the expected service life.

⁵Opaque stains are not recommended for horizontal surfaces such as trim and window sills, and it is particularly not recommended for wood decking. Opaque stains work best when applied to rough, un-weathered vertical surfaces.

7.2.3 Recommendation #3: Preservative Treated Wood

Where wood cannot be protected from moisture or where its service requirements demand resistance to constant moisture exposure, preservative treated wood must be considered for durability purposes. Untreated wood in ground contact or exposed to constant moisture in exterior above-ground applications will rot within a short period of time, generally less than two years.

The most common wood preservative treatment is Copper Chromium Arsenate (CCA). In fact, 98% of all water-borne preservatives used to treat wood in 1997 was CCA (source: American Wood-Preservation Association, Wood Preservation Statistics, 1997). CCA, which leaves wood with a light-greenish tint, has excellent decay resistant qualities when properly specified. It lasts more than 30 years without decay in exposure tests when properly treated. CCA also repels insect infestation. The most important characteristic for proper treatment is the amount of chemical that impregnates the wood and that is retained after treatment. Recommended retention levels for CCA are given in Table 7.2.

There are several other CCA-like treatments (e.g., ACQ, boric acid) that require similar levels of retention for effectiveness. It is also worth noting that CCA is not the recommended treatment for every species of wood. In the west, for instance, Douglas fir treated with CCA shows poor performance.

Some pointers to ensure good performance of treated wood are as follows:

- Allow several weeks for treated lumber to dry before installation (it is generally wet due to the water-borne treatment process); if installed wet, fasten securely to prevent warping and back-out of fasteners.
- For treated wood that is to be installed immediately or painted, consider specification of “kiln-dried after treatment” (KDAT) lumber.
- Treat field-cut ends of preservative treated

lumber with an over-the-counter wood preservative; for thick lumber, preservative treatment does not penetrate to the middle of the member.

- Put factory cut and treated ends in the more severe location (e.g., ends of posts in ground).
- Use preservative treated lumber that is labeled and certified by an American Lumber Standard Committee (ALSC) inspection agency and that is treated in accordance with American Wood Preservers’ Association (AWPA) standards.
- Once dry or slightly weathered, treat exposed wood with a penetrating stain and water-repellent (unless other finishes are desired).
- Do not use opaque stains or latex paints on deck surfaces; use only special “deck” paint if solid color is desired.

7.2.4 Recommendation #4: Fasteners and Corrosion Resistance

Depending on application conditions, there are several options for fastener selection. Fasteners used within a building’s weather barrier are generally protected from corrosion and, therefore, do not usually require special consideration regarding durability. However, in exterior exposures, the durability of fasteners and metal connectors is a major issue. The following recommendations are intended to give reliable, long-term performance:

- Siding nails, as well as nails in treated wood exterior framing (i.e., decks) should be galvanized (preferably hot-dipped). Bolts should also be hot-dipped galvanized rather than electroplated.
- In particularly severe environments (e.g., exterior construction subject to salt-

TABLE 7.2 - RECOMMENDED PRESERVATIVE RETENTION LEVELS FOR CCA-TREATED LUMBER

<u>Application</u>	<u>Retention (lb. per cu. ft. of wood)</u>
Above grade (decking, trim, railings, etc.)	0.25
Ground contact (sills, posts, not in ground)	0.4
Foundations (below ground)	0.6
Marine	2.5

spray from the ocean), stainless steel fasteners and hardware should be considered, although thicker than normal galvanic coatings (i.e., G90 or higher) are acceptable. Situations in which galvanized metal fasteners, such as joist hangers, are subjected to periodic salt deposition without the possibility of rinsing from rain (e.g., under a deck) should be avoided.

- Stainless steel siding nails are often used to prevent rust staining in any environment; deformed shank siding nails are also preferable to prevent nail back-out caused by moisture cycling of the wood.
- Siding and roofing nails should be installed in dry wood. Wet wood, when it dries, will lose some of its holding power on the nail.

Proprietary coatings on pneumatic fasteners are available and should be used only as recommended by the manufacturer. These coatings are generally similar to electroplated galvanic coatings, but special alloys are sometimes used to enhance corrosion resistance. Mechanically coated nails are also found in the market with coating thickness and characteristics similar to electroplated galvanic coatings. Galvanic coating thickness and environmental conditions are the primary factors in determining the time until the onset of rust. Service life of nails under normal exterior conditions is shown in Table 7.3.

Other non-corrosive metals may also be available for some types of fasteners (e.g., copper or aluminum). However, aluminum and copper can be reactive with other metals or environmental conditions. For example, aluminum or copper nails should not be used with galvanized metal connectors. For best results, fasteners and attached metallic materials should always be of the same type of metal.

7.2.5 Recommendation #5: Alternatives to Wood Exteriors

As a final recommendation to prevent the decay of exterior wood, there are many new products available that serve as replacements to wood. Recently, several engineered wood composites have been introduced and subsequently encountered durability failures (see Section 2.5 – Common Performance Problems). This has left many builders skeptical of engineered wood products for exterior use. However, with suitable installation and climate conditions, most engineered wood products have performed well. Similarly, exterior insulation finish systems (EIFS) encountered serious problems related to durability and moisture damage. On the other hand, some products like vinyl siding and vinyl-clad or vinyl windows have been used with great success and increased frequency. Therefore, it is worthwhile for designers and builders to consider new materials that offer promise of durability or affordability, or both. Some of these products include:

- Vinyl siding and trim products;
- Vinyl windows and doors;
- Plastic trim products;
- Plastic coated foam, molded plastic, or fiberglass trim products that are UV-resistant and that are paintable/stainable;
- Plastic lumber decking and posts;
- Fiber cement siding and trim products; and
- Fiber cement boards, siding, and trim.

Most of these products have been in use for some time and, if required, include UV inhibitors to protect against dry rot.

Untreated, non-decay resistant wood species exposed to the weather (without ground contact or protective coating) will generally last between 2 and 20 years depending on the severity of the climate (see Decay Index Map, Figure 4.3). On the other hand, properly treated or naturally decay-resistant wood will last more than 20 years without significant decay, almost regardless of climate.

TABLE 7.3 - NO-RUST SERVICE LIFE OF NAILS EXPOSED TO NORMAL OUTDOOR ENVIRONMENT

<u>Nail Type</u>	<u>Coating Thickness, mils (1/1000 of inch)</u>	<u>Service Life</u>
Galvanized (electroplated or mechanically plated)	0.2 (varies)	5 - 10 yrs
Hot-dipped galvanized	2 to 6	20+ yrs
Stainless Steel	N/A	50+ yrs

Although many new materials can provide desirable qualities, an “old-timer” with a taste for tradition may desire traditional products. In this case, the builder or the client must be willing to pay to get some of the expensive naturally-decay resistant wood products that are still available, such as straight grain red cedar or heartwood Douglas fir. Alternatively, treated wood that can be used with paints and stains may be selected. Coating manufacturer recommendations should be carefully consulted.

The most important concern is to choose appropriate siding and trim material and detailing for the climate. In severe climates (e.g., hot and humid), it may be wise to remain conservative or at least to run “field test” on a shed or some other harmless application. When experimenting, purchase a moisture meter and take the time to observe the performance of the new product as well as some of your current materials and methods. It is always best to run “side-by-side” comparisons of identical buildings. Alternatively, you may receive some help in performing your own tests or certified laboratory tests by calling the ToolBase Hotline at 800-898-2842 or sending your request for information to askanexpert@nahbrc.org. ToolBase is a service of the NAHB Research Center and is sponsored by NAHB, CertainTeed, HUD, the North American Steel Framing Alliance, the Wood Truss Council of America, the Wood Promotion Network, and others.

CHAPTER 8 - Natural Hazards

8.1 General

Severe damage to homes is often seen in media reports following major natural disasters, such as Hurricane Andrew in Florida and the Northridge Earthquake in California. As a result, the most prevalent (and less interesting) forms of damage that have “common sense” fixes are rarely given the degree of consideration they deserve.

From past scientific surveys of hurricane damage, it can be seen that damage to roofing and water damage to contents are the most frequent and costly repairs. For example, damage statistics for Hurricane Andrew and Hurricane Opal (Florida) are shown in Table 8.1. It can be seen that the most significant forms of damage were associated with roofing loss. In Hurricane Andrew, a particularly severe Category 5 event, roof sheathing loss and window breakage were also prevalent. Since the data presented in Table 8.1 was collected using a random sample of the housing stock in each event, the findings approximately represent the overall housing stock performance.

Light wood-frame homes are well-known for their resiliency in earthquake events as evidenced by the low frequency of collapse, even in extreme earthquakes. However, because homes are the most common type of structure, they account for much of the overall damage, but usually in the form of cracked interior and exterior finishes. As shown in Table 8.2, more serious forms of structural damage to foundations and walls are a relatively rare occurrence.

Based on the above data, which identifies key issues related to durability of homes in natural disasters and places them in the proper perspective, the following section gives some recommended practices to improve performance at a modest cost. Other forms of disaster include wildfires, hail, tsunamis (tidal waves), etc. For fire resistance, fire resistant siding and roofing materials as well as landscaping that reduces fuel sources near to the home may be used. For hail, resistant roofing products, such as tile or specially rated asphalt shingles, may be considered. Properly installed metal roofing is also a good option for wind, hail, and fire resistance.

TABLE 8.1 - HURRICANE DAMAGE STATISTICS (SINGLE-FAMILY HOMES)

Component	Frequency of Moderate to Severe Damage (% of all homes)	
	Hurricane Andrew [165 mph gusts]	Hurricane Opal [100-110 mph gusts]
Roof sheathing	64%*	2%*
Walls	2%	0%
Foundation	0%	0%
Roofing	77%	4%
Interior finish	85%	Unknown

Sources:

(1) NAHB Research Center, Inc., Assessment of Damage to Single-Family Homes Caused by Hurricanes Andrew and Iniki, U.S. Department of Housing and Urban Development, Washington, DC, 1993.

(2) NAHB Research Center, Inc., Assessment of Damage to Homes Caused by Hurricane Opal, prepared for the Florida State Home Builders Association by the NAHB Research Center, Inc., Upper Marlboro, MD, 1996.

*Percent value of homes which lost one or more roof sheathing panels.

**TABLE 8.2 - NORTHRIDGE EARTHQUAKE DAMAGE STATISTICS
(PERCENT OF SINGLE-FAMILY HOMES)**

Component	No Damage	Low Damage	Moderate Damage	High Damage
Foundation	90.2%	8.0%	0.9%	0.9%
Walls	98.1%	1.9%	0.0%	0.0%
Roof	99.4%	0.6%	0.0%	0.0%
Exterior finish	50.7%	46.1%	2.9%	0.3%
Interior finish	49.8%	46.0%	4.2%	0.0%

Source: NAHB Research Center, Inc., *Assessment of Damage to Residential Buildings Caused by the Northridge Earthquake*, prepared for the U.S. Department of Housing and Urban Development, Washington, DC, 1994.

8.2 Recommended Practices

8.2.1 Recommendation #1: Hurricane-Prone Areas

The following recommendations will assist in improving the durability of homes in areas prone to frequent high winds resulting from tropical storms or hurricanes:

- Nail roof sheathing according to manufacturer's fastening schedule, using pneumatic or hand driven 8d deformed shank fasteners or screws.
- Use the "6-nail" method for attaching 3-tab roof shingles; make sure the roof deck is dry prior to installation; follow installation instructions on the packaging.
- Apply roofing cement (mastic) to the underside of shingle tabs along the roof perimeter and ridge.
- Use 15# felt roofing underlay and flashings as shown in Chapter 4.
- Use moderate sloped roofs of 4:12 to 6:12 to minimize wind uplift while avoiding large lateral loads on the building; in general, hip roofs perform better than gable roofs.
- Consider low-profile plans (i.e., a one-story home is less vulnerable than a two-story home).
- Use hurricane ties or clips to attach the roof to the walls; in severe coastal exposures make sure that the load transfers either through the sheathing or through additional brackets down to the foundation; it doesn't take much effort or hardware to make a big difference.
- If building on the beach, elevate the house above the local base flood elevation and set-back as far as possible from the coastline;

expect damage at some point in time – coastal exposures are quite threatening in hurricane-prone regions.

- Use the services of a knowledgeable design professional for complex or "non-conventional" plans; make sure the detailing is clearly shown on the plans or construction shop drawings prior to the start of construction.

8.2.2 Recommendation #2: Earthquake-Prone Areas

For areas prone to earthquakes, the following practices may be used to improve durability:

- Use continuous wood structural panel sheathing on all exterior walls.
- Avoid stucco and similar brittle exterior finishes (cracks will be apparent and require repair in moderate to strong events and may also leak in future rain); however, stucco can provide a very stiff and strong building that also minimizes interior finish cracking in moderate earthquakes.
- Avoid steeply sloped sites or sites with "soft" soils that may liquefy during ground shaking.
- Consider low profile plans (i.e., one-story instead of two-story home).
- Avoid heavy roofing materials.
- Use the services of a knowledgeable design professional for complex or non-conventional plans in hazardous earthquake regions.

- Secure heavy equipment such as water heaters and storage tanks and use flexible gas lines to natural gas appliances.
- Advise homeowners to secure furnishings, such as bookshelves and wall hangings, to prevent damage or injury.

8.2.3 Recommendation #3: Inspection

Generally, connections are a key area where wind damage occurs and, to a lesser degree, earthquake damage in single family homes. Care should be taken to inspect for the proper connection of roof and wall sheathing, as well as any required brackets or metal connectors. In high wind areas, inspection of roof sheathing nails into a gable end truss (gable roof) is particularly important. To obtain thorough inspection, some builders and designers include special inspection services within the scope of contracts as a matter of business practice.

To assist builders and framers in obtaining the maximum level of quality possible, the NAHB Research Center has initiated the Framing Quality Assurance Program (1-800-638-8556). The program is ISO 9000 based and requires adoption of effective quality procedures as well as periodic auditing by a third party.

8.2.4 Recommendation #4: Flood-Prone Areas

Flood-prone areas include many coastal zones subject to storms as well as land near waterways that periodically experience flooding. A few simple design considerations for these areas that can increase house durability include:

- Install components like HVAC blowers, electrical receptacles, and hot water heaters at elevated locations in basements. This practice can make recovery easier and less hazardous.
- Consider the use of back-flow restriction valves to reduce the risk of sewer water backup into houses during flood events.
- Do not build in the 100-yr flood plain or follow appropriate construction guidelines and regulations for flood-resistant construction (i.e., elevated foundation).
- Do not use moisture-sensitive building materials and finishes below the first above-grade floor.

CHAPTER 9 - Miscellaneous

9.1 General

The previous chapters of this book have dealt with significant durability issues that can impact the functionality and livability of a home. There are other durability-related issues in homes that do not necessarily increase the risk to the structure or the occupants, but which, nevertheless, are often quite important to occupants. The presence of these nuisance items often leads to perceptions of poor quality and durability. The consumer is no less concerned with these nuisances than a leaking window caused by improper flashing or a damp basement caused by inadequate site drainage. Nuisances include items such as nail pops or premature wear of a product or surface. This chapter focuses on how to address expectations when dealing with some of the more common problems in this category.

One of the largest obstacles to overcome is separating normal wear and tear from premature wear. As in other parts of the home, this requires understanding and managing expectations. For example, carpets, paints and other interior finishes are generally expected to wear out over time. Although there are certainly better grades of these products, they often come with a higher cost. In other words, consumers need to understand that they usually “get what they pay for” when selecting finish materials. Because there is some amount of personal choice involved in selecting finish materials, this document does not attempt to prescribe one type of product over another. However, where appropriate, some options are identified where different types of finishes may prevent premature wear or prevent common problems with finishes.

Recommendation #1: High Traffic Areas

Use wear-resistant surfaces in high traffic areas. Bathrooms, kitchens, and entryways face more severe exposure than other areas of the home. Old standbys like tile, hardwood, and vinyl certainly are good products for some of these areas. Also consider some of the new laminates that give the

look of wood but which have better resistance to wear and scratches. A newer trend that appears to be growing is the use of stained or pigmented concrete floors.

Recommendation #2: Finish Selection

Select finishes and colors that can mask dirt in high traffic areas. In addition to wear in high traffic areas, keep in mind that darker colors are better at masking dirt carried in from outside. Although nearly all carpets today are better at resisting stains, evidence suggests that lighter colors contribute to complaints about carpet soiling (see next section).

Recommendation #3: Carpet Soiling

Carpet soiling is a phenomenon where soils, combustion particles, and other particulates accumulate at the base of walls, under interior doors, and other areas. The result is dark, linear stains along these surfaces. In the most severe cases, it cannot be removed by cleaning. Carpet soiling can be minimized through the use of darker carpet colors, multiple return-air grilles (as opposed to central returns), passive returns or jump ducts from bedrooms, and occupant education about the implications of using candles in the home.

Recommendation #4: Stuck Windows

Windows and doors can stick or be difficult to open and close for a number of reasons. Problems typically result from the swelling of framing around openings or excessive deflection in headers.

One way to reduce header deflection is to size the headers with sufficient stiffness. It is important to recognize, however, that even with proper sizing, temporary deflection and even permanent deflection can occur and possibly interfere with window operation. A common practice that contributes to

inoperable windows is shimming between the window frame and the header. This space should be left open to allow for deflection of the header.

To avoid the swelling of materials and subsequent problems with the operation of doors and windows, the entry of water must be prevented by the use of proper drainage and flashing details. It is very important to ensure that siding is installed according to the manufacturer's specifications. Do not assume that the same details that work with one type of exterior finish will work with others or that all windows or doors are the same with respect to the frame's water tightness.

Finally, when using an air-sealing foam to plug air leaks around window frames, use low-expansion foams that don't deflect the frame as they expand and harden. Non-expanding products, such as caulk or fiberglass, can be used instead. However, some window manufacturers void their warranties if such products are used around their window frames.

Recommendation #5: Nail Pops and Drywall Cracks

Cracks, visible seams, and nail pops are some of the most common interior finish complaints lodged by homeowners. Although it can't be guaranteed that a home will be immune from these problems, some strategies can be adopted to minimize their chances of occurring. One strategy calls for developing specifications for drywall and framing contractors that clearly outlines expectations. Another equally important strategy is follow-up supervision of contractors. During construction, consider adopting the following:

- Install finishes only to sufficiently dry lumber (i.e., 12% moisture content or less) and use a moisture meter to check conditions.
- Heat homes and keep humidity low to limit chances that joint compound will cure either too quickly or slowly and cause seams to crack.
- Reduce shrinkage that causes nail pops and cracks by specifying only kiln-dried lumber.
- Hang drywall to minimize joints directly at the ends or over headers or other openings.
- Consider stiffer floor and ceiling framing to minimize deflection that can create cracks along seams.
- Use two-stud corners and drywall clips to minimize cracks at outside corners.

- When installing drywall on ceilings, float (i.e., do not fasten) the ends of the sheets at wall intersections. This will avoid cracking if the trusses move.

Recommendation #6: Floor Squeaks

Noisy floors are one of the most common callback problems for builders. Floors, like other parts of a home, are subject to movement. The most typical noise is related to loose nails or other fasteners that squeak when a person walks across the floor. Sometimes, noise is the result of movement of the floor sheathing when attachment is insufficient (too few fasteners) or when the sheathing is not pulled tight to the joist. In other cases, fasteners that miss the floor joist below and end up alongside the joist create noise when the joist deflects and the nail rubs against it. Recommendations include:

- Use only kiln-dried lumber, which is marked "KD."
- Install the correct number, spacing, and type of fastener into the sheathing. Specify these items to your trade contractor.
- Consider screws or deformed shank nails as opposed to smooth shank nails to reduce movement of the fasteners.
- Consider the use of adhesives to help limit sheathing movement. Adhesives can stiffen the floor and reduce bounce. But be careful—an adhesive that sets up too soon (e.g., in cold weather applications) can contribute to squeaks by preventing the sheathing from pulling tight to the floor joists.

Recommendation #7: Subfloor Material

Select subfloor material keeping in mind the finished floor, the tolerance of the flooring for unevenness, and the expected weathering that the subfloor will experience during construction. One option is to use special moisture-resistant oriented strand board (OSB) subfloor sheets to reduce edge swelling when exposure to moisture during construction is unavoidable.

Recommendation #8: Paints and Corners

Consider application-appropriate paints to keep walls fresh looking. Glossy paints are easier to clean and should be considered for use on doors, trim, and other high traffic areas. Flat or matte finishes give a softer, more appealing texture for interior wall surfaces while hiding imperfections. Fortunately, there are now paints on the market that come with a flat finish but are washable. These make a great finish in areas such as kitchens, mud rooms, bathrooms, and children's rooms when a flat look is desired.

Also, consider the durability of wall corners to reduce dents, chips, and other damage by occupants by using prefabricated corners to aid in damage reduction. For more information about available products, see the PATH website at www.pathnet.org.

9.2 Plumbing

Recommendation #1: Pipe Material

Choose the right plumbing material for the water supply and local conditions. In most locations of the United States, copper and plastic (e.g., CPVC) are viable products. But sometimes, one is advantageous over the other. It is often advisable to check with local plumbers and code officials to determine if there is a history of local conditions that would lead to a preference for a certain material. For example, are there reports of aggressive soils or water that may attack the material?

Recommendation # 2: Washing Machine Leaks

One of the leading causes of insurance claims is water damage from burst washing machine hoses. With the trend toward finished basements and the increasing placement of laundry areas on main floors and second floors, the potential for damage is increasing. Simple tools to remind homeowners to inspect/replace hoses (e.g., magnets with inspection schedules to fill out) are available. Care should also be taken to address drainage in case a leak occurs. A drainage system and catch basin large enough to accommodate the washing machine and the area surrounding the hose connection is always recommended. When replacement hoses are purchased, high quality hoses should be selected.

Recommendation # 3: Frozen Pipes

In cold climates, protect water pipes against freezing. The best approach is to keep all water pipes within the thermal envelope. This becomes difficult in vented, unconditioned crawlspaces where risers may need to be insulated and operable vents should be closed in the colder periods of the year. Alternatively, an insulated, unvented crawlspace can be used (see Section 4.2.6).

Recommendation #4: Plumbing Units

Select certified kitchen and bath fixtures to reduce the possibility of premature failure. Tubs, sinks, shower stalls, and countertops of every type and grade should meet some minimum standards to prevent chips, cracks, leaks, or excessive wear and tear. Look for the NAHB Research Center label or other label from a reputable quality assurance agency that lists these products.

Recommendation #5: Bath Room Design

Consider use of seamless tub and shower units to reduce reliance on sealants. Inspect for leakage around bathroom fixtures and replace seals and sealants as required. Use cement-based backer board behind tile finishes.

9.3 HVAC

The issues with HVAC systems primarily relate to comfort, and in a few cases, potential moisture problems. As a side benefit, actions taken to address these issues generally tend to improve the energy efficiency of the home.

Recommendation # 1: Duct Leakage

Leaky ducts can lead to a host of problems – dry air, humid air, condensation, among others. The problems that can occur depend on the location of ducts and the climate. The safest bet is to simply build tightly sealed duct systems. Tight ducts will alleviate potential problems and increase the efficiency of an HVAC system. Designing the home with the duct system entirely within the thermal envelope also helps to head off problems.

Recommendation # 2: House Air Leakage

Keep air infiltration through cracks in the building envelope to a low level. Like a leaky duct, a leaky structure also brings in outdoor air and can result in uncomfortably dry indoor conditions during the heating season. Air sealing is becoming a more common component of the energy package for homes and is an effective practice with or without the inclusion of a separate air barrier (i.e., building wrap). But, be aware that an aggressive approach can make a home too tight, which results in the need for supplemental ventilation. A blower door test can be performed to estimate the air infiltration rate.

Recommendation # 3: Load Sizing

Use proper methods such as Air-Conditioning Contractor's Association (ACCA) Manual J (software version is called Right-J) for determining design heating or cooling loads and HVAC equipment sizes. Rules of thumb for sizing should not be used.

Bigger is not always better! Oversized equipment can lead to moisture problems since the air-conditioner may not run long enough to adequately dehumidify indoor air during summer cooling months.

Recommendation # 4: Exhaust Ventilation

Use exhaust fans in all full bathrooms and near other moisture sources in the house, such as kitchen ranges. With larger floor plans and more interior-room bathrooms in homes, moisture from showering has no place to go without an exhaust fan.

Bath fans are often rated for a specific flow at 0.1" water column (wc). This static pressure roughly correlates to an air grille, five feet of 3-inch flex duct, and an end point cap. As-built installations are commonly more extensive than this, and static pressure levels are greater. Therefore, fans will often exhaust as little as ½ of their rated capacities due to long duct runs, hoods, and grilles. It is often advisable to select a fan based on airflow at 0.25" wc. Rated flow is usually listed on the fan packaging, or consult manufacturer's literature. Alternatively, use of a 4-inch or larger diameter fan duct will result in improved air flow in comparison to standard units with 3-inch diameter ducting. Also, rigid metal duct is less restrictive than "flex" duct.

9.4 Exterior Finishes

Recommendation #1: Drainage

Provide positive drainage away from patios, sidewalks, driveways, and other concrete flatwork to reduce frost heave and other water-related damage. Drainage starts with a solid base/subgrade and ends with proper grading at a 2% or greater slope...air-entrained concrete can also help improve durability.

Recommendation # 2: Siding Installation

Check siding for appropriate installation to avoid buckling. Vinyl and metal sidings expand and contract from changes in temperature. Nearly all of these products should not be nailed or screwed tight to the structure, but rather, they should be "hung" from the nail or screw to allow for movement. It is also important to leave room where the siding abuts channels or corner trim. When properly installed, each piece of siding should be able to move sideways and up and down slightly.

A problem that commonly occurs with horizontal siding is buckling at rim joists as a consequence of shrinkage of the large dimension lumber. To avoid potential callbacks, consider engineered wood (i.e., OSB) for rim joists. If engineered wood rim joists are used, however, special details for anchoring decks to the house must be used because the web section of many engineered wood joists is not suitable for this purpose.

Recommendation # 3: On-Site Conditions

Protect doors, floor sheathing and other products against delamination or swelling by keeping them protected from the elements when stored at the job site. This practice addresses long-term problems that are not immediately noticeable, such as slight bumps in the floor at cut edges of sheathing that cause increased, localized wear of floor coverings. Other problems that result from site conditions can become noticeable very quickly. Examples include warping of wood products, staining or mold growth, and weakening of some materials.

The best approach is to minimize exposure of sensitive products to the elements. Inspect materials for pre-existing damage when they arrive on site. Stage construction so that sensitive materials are covered as soon as possible or provide a dry storage area for these products.

Bibliography

General

ASHRAE 1985 Fundamentals Handbook, American Society of Heating, Refrigeration, and Air-Conditioning, Inc., Atlanta, GA, 1985.

ASHRAE 1993 Fundamentals Handbook, American Society of Heating, Refrigeration, and Air-Conditioning, Inc., Atlanta, GA, 1993.

ASHRAE 1997 Fundamentals Handbook, American Society of Heating, Refrigeration, and Air-Conditioning, Inc., Atlanta, GA, 1997.

Structures and Environment Handbook, Eleventh Edition, Midwest Plan Service, Iowa State University, Ames, Iowa, 1983.

Residential Structural Design Guide, 2000 Edition, U.S. Department of Housing and Urban Development, Washington, DC, 2000.

Prevention and Control of Decay in Homes, U.S. Department of Housing and Urban Development, Washington, DC, 1978.

Wood-Frame House Construction, Agriculture Handbook No. 73, U.S. Department of Agriculture, Forest Service, Forest Products Laboratory, Madison, WI, revised April 1975.

Caring For Your Home: A Guide to Maintaining Your Investment, National Association of Home Builders Home Builder Press, Washington, DC, 1998.

Your New Home and How to Take Care of It, National Association of Home Builders Home Builder Press, Washington, DC, 2001.

A Builder's Guide to Marketable, Affordable, Durable, Entry-Level Homes to Last, U.S. Department of Housing and Urban Development, Washington, DC, 1999.

Residential Construction Performance Guidelines, National Association of Home Builders, Washington, DC, 2000.

Foundation/Site (Chapter 3)

Design Guide for Frost-Protected Shallow Foundations, Sponsored by the U.S. Department of Housing and Urban Development and the U.S. Department of Energy, NAHB Research Center, Inc., Upper Marlboro, MD, 1996.

Flashing (Chapter 4)

McDaniel, P., "Wrapping the House: Do's & Don'ts," *Journal of Light Construction*, March 2000.

Preventing Damage from Ice Dams, Technical Bulletin (Form No. 215-RR-87), Asphalt Roofing Manufacturers Association, Calverton, MD, March 1993.

McCampbell, H., "Troubleshooting Roof Leaks," *Journal of Light Construction*, October, 1999.

Larson, J. R., "How to Avoid Common Flashing Errors," *Fine Homebuilding*, April/May 1998.

Arnold, R. and M. Guertin, "Installing Vinyl-Clad Windows," *Fine Homebuilding*, February/ March 2000.

Carrier, J., "Keeping Water Out of Brick Veneer," *Journal of Light Construction*, November 1999.

SMACNA, *Architectural Sheet Metal Manual*, 5th Edition, Sheet Metal and Air Conditioning Contractors National Association, 1993.

Housewrap (Chapter 4)

Bosack, E. J. and E. F. P. Burnett, *The Use of Housewrap in Walls: Installation, Performance and Implications*, PHRC Report No. 59, The Pennsylvania Housing Research Center, University Park, PA, December 1998.

Light Frame House Construction, Technical Information for the use of Apprentice and Journeyman Carpenters, Vocational Division Bulletin No.145, U.S. Department of Health, Education, and Welfare, Washington, DC, 1931 (reprinted 1956).

Ventilation Issues (Chapter 4)

Cushman, T., "Roof Venting: How Much Is Enough?," *Journal of Light Construction*, December 1996.

TenWolde, A. and W. B. Rose, "Issues related to venting of attics and cathedral ceilings," *ASHRAE Transactions*, V. 105, Pt. 1, American Society of Heating, Refrigerating and Air-Conditioning Engineers, Inc., Atlanta, GA, 1999.

Fugler, D. W., "Conclusions from ten years of Canadian attic research," *ASHRAE Transactions*, V. 105, Pt. 1, American Society of Heating, Refrigerating and Air-Conditioning Engineers, Inc., Atlanta, GA, 1999.

Recommended Practices for Controlling Moisture in Crawl Spaces, ASHRAE Technical Data Bulletin, Volume 1Q, Number 3, American Society of Heating, Refrigerating and Air-Conditioning Engineers, Inc., Atlanta, GA, 1999.

Rose, W. B. and A. TenWolde, "Moisture Control in Crawl Spaces," *Wood Design Focus*, Forest Products Society, Madison, WI, Winter 1994.

Rose, W. B., "Heat and moisture performance in attics and cathedral ceilings," *Wood Design Focus*, Forest Products Society, Madison, WI, Winter 1994.

Best, Don, "Crawlspace ventilation update," *Journal of Light Construction*, August 1999.

Insects (Chapter 6)

Wood Handbook – Wood as an Engineered Material, U.S. Department of Agriculture, Forest Products Laboratory, Madison, WI, 1999.

Design of Wood Frame Structures for Permanence, National Forest Products Association, Washington, DC, 1988.

Manual of Acceptable Practices, Vol. 4, U.S. Department of Housing and Urban Development, 1973.

Hu, X.P., D. Ring, A. Morgan, D. Pollet, *A Guide for Integrated Pest Management of Termites*, AgCenter, Louisiana State University, LA., 2000.

Mankowski, M. and J.J. Morrell, "Incidence of Wood-destroying organisms in Oregon residential structures," *Forest Products Journal*, Vol. 50, No. 1, Forest Products Society, Madison, WI, January 2000.

Kard, B., "Termite Control: Results of Testing at the U.S. Forest Service," National Pest Control Association, Dunn Loring, VA, October 1998.

Kard, B., "Termiticides – The Gulfport Report," *Pest Control*, Advanstar Publications, U.S.A., February 1999.

Approved Reference Procedures for Subterranean Termite Control, National Pest Control Association, Dunn Loring, VA, 1991.

Decay & Corrosion (Chapter 7)

see General plus:

- McDonald, K.A., R.H. Faulk, R.S. Williams, J.E. Winandy, *Wood Decks: Materials, Construction, and Finishing*, Forest Products Society, Madison, WI, 1996.
- Micklewright, James T., "Wood Preservation Statistics 1997," prepared for the American Wood-Preservers' Association, Granbury, TX, 1998.
- Smulski, Stephen, "Preservative-treated wood, lumber that can last a lifetime," *Fine Homebuilding*, No. 63, October/November 1990, pp.61-65.
- Baker, A.J., "Corrosion of nails in CCA- and ACA-treated wood in two environments," *Forest Products Journal*, Vol. 42, No. 9, September 1992.

Natural Disasters (Chapter 8)

- Assessment of Damage to Single-Family Homes Caused by Hurricanes Andrew and Iniki*, U.S. Department of Housing and Urban Development, Washington, DC, 1993.
- Assessment of Damage to Homes Caused by Hurricane Opal*, prepared for the Florida State Home Builders Association by the NAHB Research Center, Inc., Upper Marlboro, MD, 1996.
- Assessment of Damage to Residential Buildings Caused by the Northridge Earthquake*, U.S. Department of Housing and Urban Development, Washington, DC, 1994.
- Sciaudone, J., "Non-Structural Seismic Retrofits Can Make a Bit Difference," *Building Standards*, Vol. LXIX, No. 6, International Conference of Building Officials, Whittier, CA, November-December 2000.

Glossary

Air barrier (also known as air retarder) – material(s) used in design to reduce the flow of air between indoors and outside. Air barriers may also serve as drainage planes in some cases.

Building code – a set of building construction requirements developed by national bodies which are adopted and administered by local institutions to certify that buildings (residential buildings in this case) meet certain minimum standards for structural integrity, safety, and durability.

Carpet soiling – the discoloration of carpets in houses due to a combination of conditions that usually includes airflow under doors or wall baseplates and a source of dirt, soot, or airborne particulates.

Damproofing, foundation – treatment of concrete or mortar to retard the passage or absorption of water, or water vapor, usually by applying a suitable coating to exposed surfaces.

Drainage plane – the part(s) of a building's weather barrier system that exhibits a high degree of resistance to liquid water from outdoors, usually in the form of a water resistant membrane, layer, or sheet; used in combination with appropriate flashing and sealing details at discontinuities in the wall assembly (e.g., penetrations for windows, doors, etc.) or at the drainage plane material itself (e.g., lap joints between sheets).

Drying potential – the ability or capacity of a material or combinations of materials to dry once wetted; in residential wall systems this ability is strongly influenced by the presence or absence of a vapor retarder(s) and the driving forces for drying (vapor pressures, temperature).

Durability – the ability of a material, product, or building to maintain its intended function for its intended life-expectancy with intended levels of maintenance in intended conditions of use.

Perm rating (vapor permeance) – a measure, for a given thickness, of a material's ability to transmit water vapor (1 perm = 1 gr/h* ft²*in.Hg); a high perm rating indicates that a material can readily allow water vapor to pass through it (e.g., gypsum), a low perm rating

indicates that a material will not allow water vapor to pass (e.g., plastic sheeting)

Sones – a unit of sound measurement used in HVAC applications to rate fan noise; standard bathroom exhaust fan have ratings of 4 Sones or more.

Swale – a stormwater runoff feature formed from natural materials like soil and vegetation that collects and channels water runoff; swales can serve as an alternative to curb and gutter systems, and allow for some water infiltration back into the ground instead.

Termite barrier – any building material or component which is impenetrable to termites and which drives the insect into the open where its activities can be detected.

Ultraviolet (UV) radiation – a form of energy from the sun in a non-visible wavelength that can cause chemical reactions in exposed materials and subsequent fatigue and discoloration.

Vapor retarder (also known as vapor barrier) – a layer in a building construction (wall, floor, or roof/ceiling) that restricts the diffusion of water vapor. The diffusion of water vapor can be driven by differences in vapor pressure. Water vapor will be driven from a location of high vapor pressure (i.e., high humidity) to low vapor pressure (i.e., low humidity). Typically, in cold climates the indoor air is at a higher vapor pressure than the outdoor air that is dryer and colder. The opposite is true in hot/humid climates where the lower vapor pressure is indoors (and is accentuated by use of air-conditioners and associated dehumidification). Vapor retarders have a perm rating of 1 or less.

Waterproofing (foundation) – a procedure to make a material impervious to water or dampness. The application of a material or coating to assure water repellency to a structure or construction unit.

Water vapor diffusion – the movement of water vapor (gaseous water) driven by vapor pressure differentials.

Weather barrier – general term for a combination of materials including siding, roofing, flashing, sheathing, finishes, drainage plane, and vapor retarders that, as a system, exhibit vapor retarding and water retarding characteristics and may also possess thermal insulation and air infiltration characteristics.

APPENDIX A - Durability Checklists

Designer's & Builder's Durability Checklist

- Have adequate roof overhangs been specified?
- Does the roof have adequate slope for the roofing material being used?
- Has valley flashing been adequately detailed?
- Has shading of the building been considered and planned?
- Have all roofing penetrations been adequately flashed and detailed?
- Have gutters been sized and specified?
- Has downspout size, location, and outlet point been detailed?
- Has roof drip edge been specified?
- Has eave ice flashing been specified, if required?
- Has 15# roofing felt been specified?
- Has attic vent location and design been specified?
- Has a secondary drainage plane been specified where required (building wrap, 15# felt, etc.)?
- Are the drainage plane and flashings at windows and doors properly detailed?
- Have window head, jamb, and sill flashing details been specified?
- Have door head flashing details been specified?
- Has siding corner detail been specified?
- Has air barrier detailing been specified, if needed?
- Has siding selection been specified?
- Have all railing details been specified?
- Has the location and flashing for utility penetrations been specified?
- Have all bathroom, dryer, and kitchen vents been specified to be directly vented to the exterior of the building?
- Does site have adequate slope to remove roof run-off?
- Has adequate foundation backfill material been specified?
- Are ground clearances between framing, siding, and ground properly maintained?
- Is treated lumber used where clearances to ground are not sufficient?
- Is foundation drain specified with proper aggregate and filter fabric?

- Are drainpipes located below the top surface of the basement slab?
- Is the foundation drainage system properly installed to provide positive flow of foundation water away from the building?
- Is foundation drain outlet specified - either through daylighting or sump pump?
- Are foundation bleed holes specified, if needed?
- Is foundation wall damp proofing or waterproofing specified as required?
- Are termite protection measures specified?
- Is basement floor gravel layer specified?
- Has crawlspace, slab, or basement floor vapor barrier been specified?

Homeowner's Durability Checklist

- Inspect/replace caulk every 2-3 years.
- Maintain gutters and downspouts in a clean and operating condition.
- Adjust landscaping sprinklers such that the house is not accidentally "watered" regularly.
- Repaint every 5-7 years.
- Maintain exterior grade near foundation for drainage away from the house.
- Maintain indoor relative humidity levels below 60% through the use of the HVAC equipment (heating during winter, cooling during summer) and auxiliary dehumidifiers in damp areas like basements.
- Inspect/replace HVAC filter monthly and have an annual service check on equipment.
- Use exhaust fans whenever showering or generating significant moisture while cooking.
- Do not exhaust clothes dryer to indoors or enclosed spaces.
- Use unvented combustion appliances only in accordance with manufacturers recommendations.
- Address all leaks and floods promptly, however small they may seem.
- Inspect/replace washer hoses periodically.

APPENDIX B - Estimated Life- Expectancy of Building Materials and Products

ESTIMATED LIFE EXPECTANCY AND HOMEOWNER MAINTENANCE CHART

<u>Building Component</u>	<u>Estimated Life* (years)</u>	<u>Homeowner Action</u>
Concrete/block foundation	100+	Check for cracks or surface deterioration. Consult a professional if you have any leaking or severe cracking. Check for termite tubes on foundation.
Exposed concrete slabs	25	Inspect for cracking. Seal to prevent water penetration.
Siding (Lifespan depends on type)	10 - 100	Clean all types of siding. Paint or seal wood siding (See exterior paints/stains).
Drywall	30 - 70	Inspect, clean, and paint for aesthetic purposes.
Roofing	15 - 30	Inspect for missing or deteriorated shingles. Clean to remove mold buildup.**
Gutters and Downspouts	30	Remove debris.
Insulation	100+	Inspect blown insulation in attic and check floor insulation (crawl space) to assure that it is in place.
Windows	20 - 50	Inspect and repair weather stripping. Inspect for broken seals in insulated windows. Clean exterior window frames.**
Exterior Doors	25 - 50	Clean and refinish when necessary (See Exterior paints/stains).
Garage Doors	20 - 50	Clean garage door. Lubricate moving parts. Paint or seal as necessary.**
Exterior paints/stains	7 - 10	Clean and inspect. Repaint and caulk as needed.
Wood floors	100+	Clean and wax.
Carpeting	11	Clean annually.

*All numbers excerpted and condensed from: NAHB Life Expectancy Survey from "Housing, Facts, Figures and Trends" (1997)

**Use care if power washing. The high pressure water can cause more harm than help if not used cautiously.

ESTIMATED LIFE EXPECTANCY AND HOMEOWNER MAINTENANCE CHART (CONTINUED)		
<u>Building Component</u>	<u>Estimated Life* (years)</u>	<u>Homeowner Action</u>
Sinks	5 - 30	Keep free of debris.
Toilets	50	Keep free of debris. Check tank seal and floor wax collar for leaks.
Faucets	13 - 20	Clean screen annually. Check for leaking seals.
Water heater	14	Keep clear of household items. Have professional maintenance annually.
Central air conditioning/ heat pump (outside unit)	15	Keep free of plants and debris. Cover during winter months (A/C only). Conduct annual professional maintenance.
Furnace/heat pump (indoor unit)	18	Keep clear of household items. Conduct annual professional maintenance. Inspect/replace filter according to manufacturer's recommendations.
Refrigerator	17	Clean condensing coils regularly; allow room behind and inside appliance for air circulation.
Dishwasher	10	Clean the drain filter regularly.
Clothes Dryer	14	Clean lint filter regularly. Periodic professional cleanings will reduce risk of fire.
Clothes Washer	13	Keep lint trap free of debris. Clean tank occasionally.
Smoke Detector	12	Test and check batteries.
Wood Framing	100+	(See termite protection.)
Termite protection (chemical treatment)	5	Yearly inspection and retreat as necessary.

*All numbers excerpted and condensed from: NAHB Life Expectancy Survey from "Housing, Facts, Figures and Trends" (1997)

**Use care if power washing. The high pressure water can cause more harm than help if not used cautiously.

U.S. Department of Housing and Urban Development
HUD User
P.O. Box 6091
Rockville, MD 20849

Official Business
Penalty for Private use \$300

Return Service Requested

FIRST CLASS MAIL
POSTAGE & FEES PAID
HUD
PERMIT NO. G-795

May 2002

